

Small Fragment Locking Compression Plate (LCP) System. Stainless steel and titanium.

Technique Guide

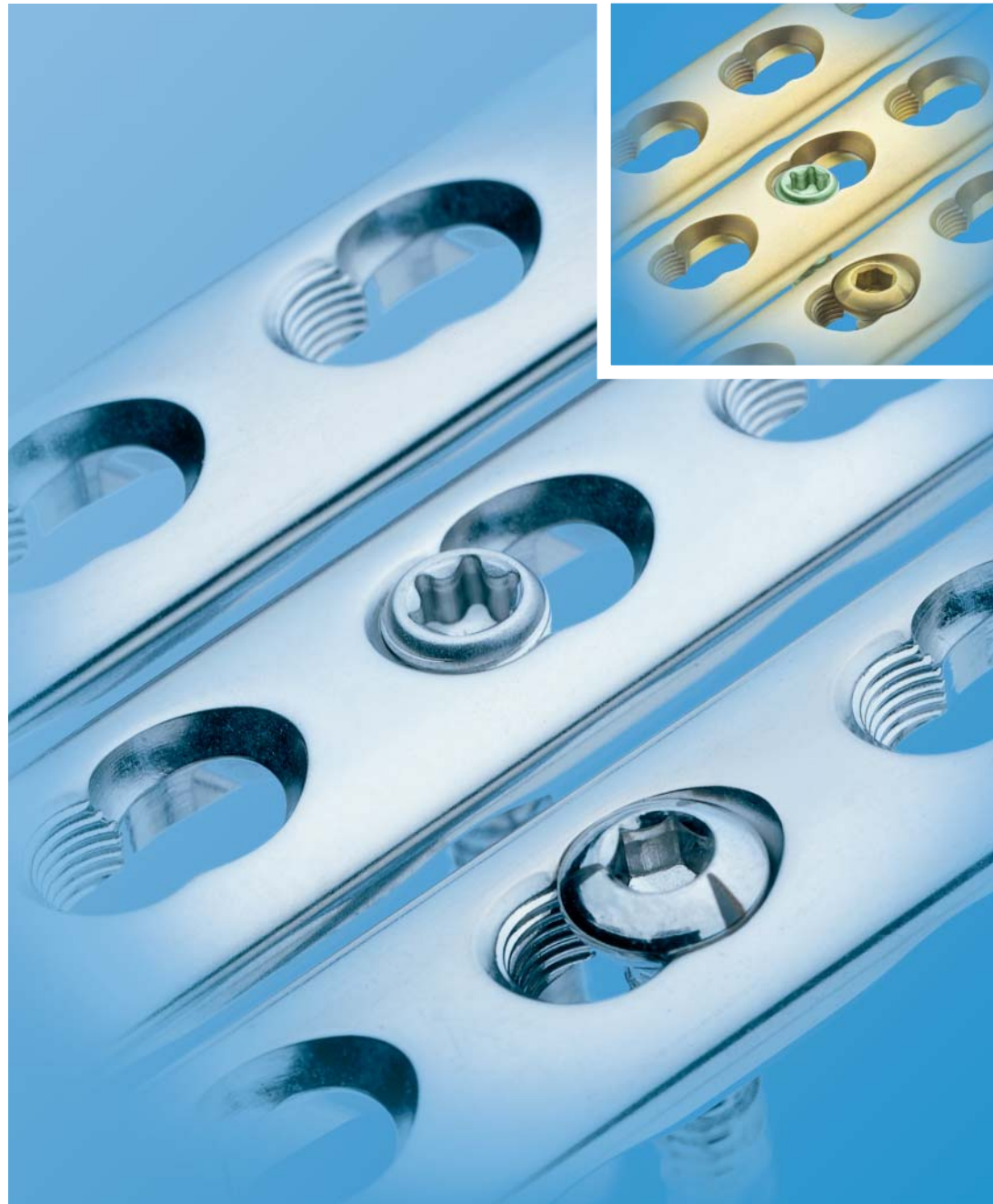

Table of Contents

Introduction

Small Fragment Locking Compression Plate (LCP) System	2
AO Principles	4
Indications	5
Fixation Principles	6

Surgical Technique

Preparation	11
Reduction and Temporary Plate Placement	12
Screw Insertion	13
Screw Placement Verification	17
Postoperative Treatment	19
Implant Removal	19

Product Information

Implants	20
Instruments	24
Set List	31

Small Fragment Locking Compression Plate (LCP) System

The aim of any surgical fracture treatment is to reconstruct the anatomy and restore its function. According to the AO, internal fixation is distinguished by precise reduction, stable fixation, preservation of blood supply and early, functional mobilization. Plate and screw osteosynthesis has been established and clinically recognized for quite some time. Clinical results have been improved by using internal fixation with angular stability (internal fixators) in metaphyseal fractures and in osteopenic bone.

The Synthes Locking Compression Plate (LCP) is part of a stainless steel and titanium plate and screw system that merges locking screw technology with conventional plating techniques. The Locking Compression Plate System has many similarities to existing plate fixation methods, but with a few important improvements. Locking screws provide the ability to create a fixed-angle construct while utilizing familiar AO plating techniques. A fixed-angle construct provides advantages in osteopenic bone or multifragmentary fractures where traditional screw purchase is compromised. Locking screws do not rely on plate/bone compression to maintain stability, but function similarly to multiple small angled blade plates.

Plate features

The Locking Compression Plates (LCP) have the following LC-DCP features:

- 80° of longitudinal screw angulation
- 14° of transverse screw angulation
- Uniform hole spacing
- Load (compression) and neutral screw positions

Locking compression plates have combination locking and compression holes (Combi holes).

The Combi holes allow placement of standard cortex and cancellous bone screws on one side or threaded conical locking screws on the opposite side of each hole.

- Threaded hole section for locking screws
- Dynamic compression unit (DCU) hole section for standard screws
- Locking screw in threaded side of plate hole
- Cortex screw in compression side of plate hole

Note: Holes in straight and reconstruction plates are oriented so that the compression component of the hole is always directed toward the middle of the plate.



223.581



241.981

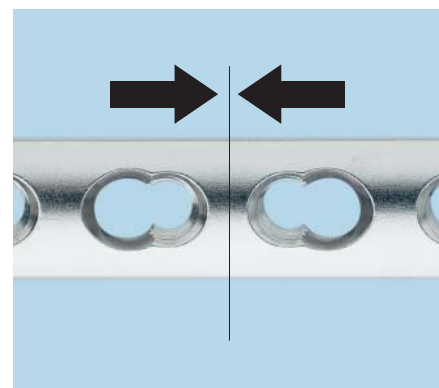
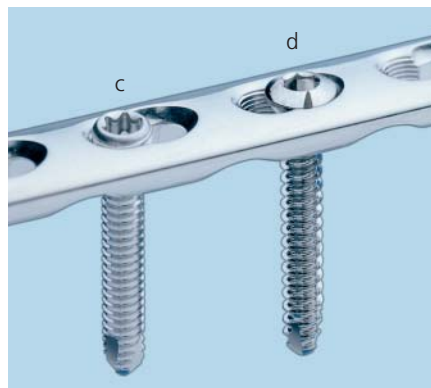
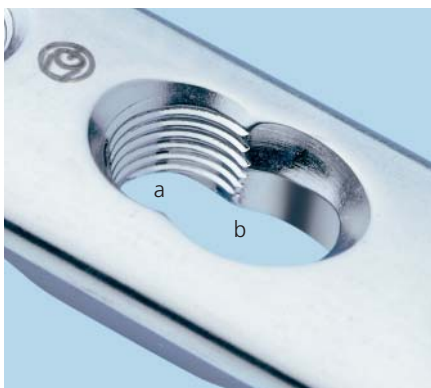

3.5 mm Locking Screws, self-tapping, with StarDrive recess

The 3.5 mm locking screws mate with the threaded plate holes to form a fixed-angle construct.

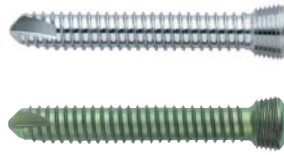

Locking screw design

The screw design has been modified, as compared to standard 3.5 mm cortex screws, to enhance fixation and facilitate the surgical procedure.

Features include:

Conical screwhead

The conical head facilitates alignment of the locking screw in the threaded plate hole to provide a secure screw/plate construct.

Large core diameter

The large core diameter improves bending and shear strength, and distributes the load over a larger area in the bone.

Thread profile

The shallow thread profile of the locking screws results from the larger core diameter, but is acceptable because locking screws do not rely solely on the screw threads to create compression between the plate and the bone to maintain stability.

Drive mechanism

The StarDrive recess provides improved torque transmission to the screw while retaining the screw without the use of a holding sleeve.

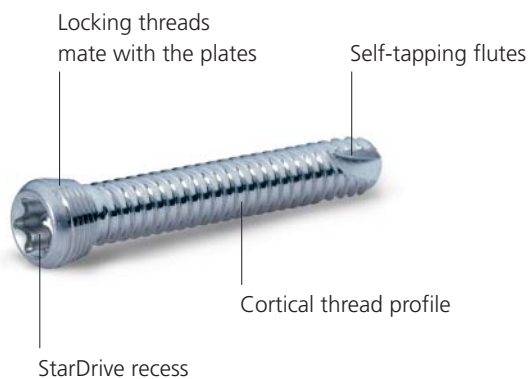

AO Principles

In 1958, the AO formulated four basic principles, which have become the guidelines for internal fixation.¹ These principles, as applied to the Small Fragment LCP implants, are:

Anatomic reduction

Facilitates restoration of the articular surface by exact screw placement using wire sleeves.

Stable fixation

Locking screws create a fixed-angle construct, providing angular stability.

Preservation of blood supply

Tapered end allows submuscular plate insertion, preserving tissue viability.

Limited-contact plate design reduces plate-to-bone contact, limiting vascular trauma and insult to bone.

Early, active mobilization

Plate features combined with AO technique create an environment for bone healing, expediting a return to optimal function.

1. M.E. Müller, M. Allgöwer, R. Schneider, H. Willenegger:
Manual of Internal Fixation, 3rd Edition. Berlin; Springer-Verlag. 1991.

Indications

Synthes Small Fragment Locking Compression Plates (LCP) are intended for fixation of fractures, osteotomies and nonunions of the clavicle, scapula, olecranon, humerus, radius, ulna, pelvis, distal tibia, and fibula, particularly in osteopenic bone.

Fixation Principles

The following points distinguish treatment using locking screw technology from conventional plating techniques:

- It enables fracture treatment using compression plating with conventional cortex or cancellous bone screws
- An LCP plate can also be used as an internal fixator and permits stable bridging over shattered zones
- The LCP system permits the combination of conventional and locking screws
- Unicortical locking screw permits better vascularity

Note: The LCP system applies to many different plate types and is therefore suitable for a large number of fracture types. For that reason, this technique guide does not deal with any specific fracture type. Please refer also to the *AO Principles of Fracture Management*,² and *AO Manual of Fracture Management–Internal Fixators*.³

Unicortical screw fixation

Bicortical screw fixation has long been the traditional method of compressing a plate to the bone where friction between the plate and the bone maintains stability. Screw stability and load transfer are accomplished at two points along the screw: the near and far cortices.

Unicortical locking screws provide stability and load transfer only at the near cortex due to the threaded connection between the plate and the screw. Screw stability and load transfer are accomplished at two points along the screw: the screwhead and near cortex. Because the screw is locked to the plate, fixation does not rely solely on the pullout strength of the screw or on maintaining friction between the plate and the bone.

- a. Bicortical screws require two (2) cortices to achieve stability.
- b. Unicortical screws utilize the locked screw and the near cortex to achieve stability.

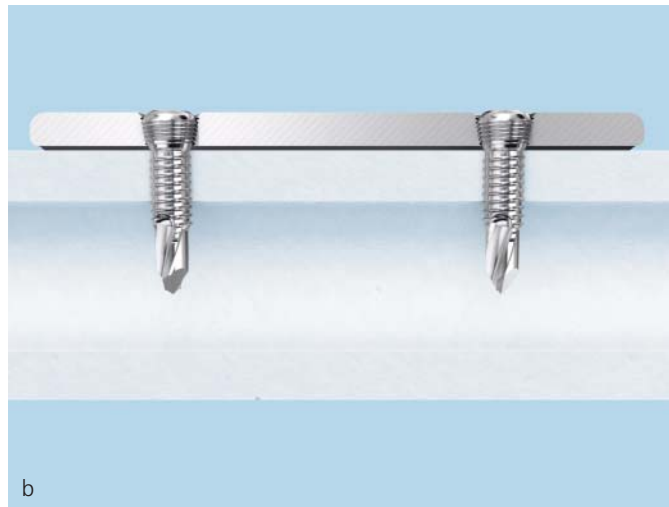
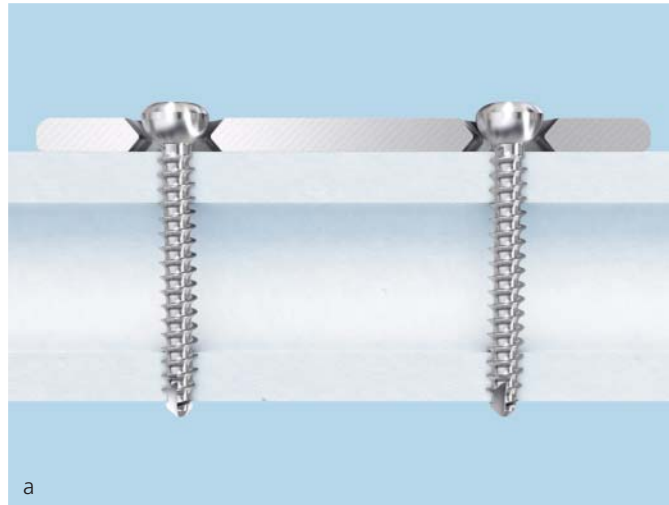

2. Thomas P. Rüedi, et al, ed., *AO Principles of Fracture Management*, New York: Thieme, 2000.

3. M. Wagner and R. Frigg, *AO Manual of Fracture Management–Internal Fixators*, New York: Thieme, 2006.

The following examples show the biomechanical features of conventional plating techniques, locked or bridge plating techniques, and a combination of both.

Conventional plating

Absolute stability

The tensile force (F1) originating from tightening the screws presses the plate onto the bone (F2). The developing friction (F3) between the plate and the bone leads to stable plate fixation. To ensure absolute stability, the friction resistance must be higher than the axial forces (F4) arising during rehabilitation.

Anatomic contouring of the plate

The aim of internal fixation is anatomic reduction, particularly in articular fractures. Therefore, the plate must be contoured to the shape of the bone.

Lag screw

Interfragmentary compression is accomplished by using a lag screw. This is particularly important in intra-articular fractures which require a precise reduction of the joint surfaces. Lag screws can be angled in the plate hole, allowing placement of the screw perpendicular to the fracture line.

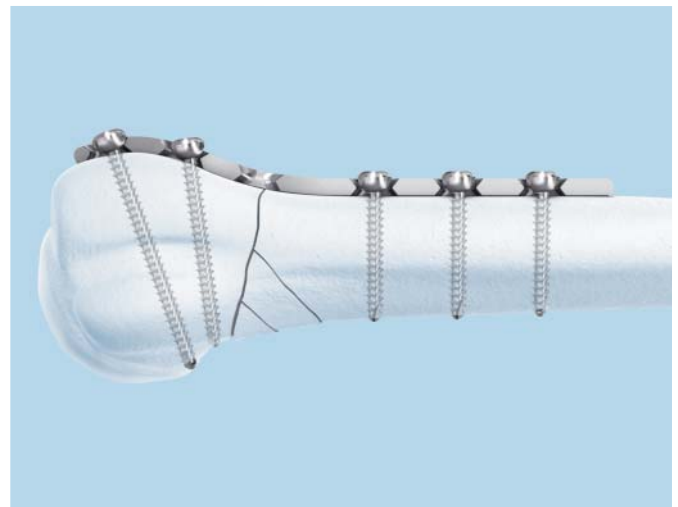
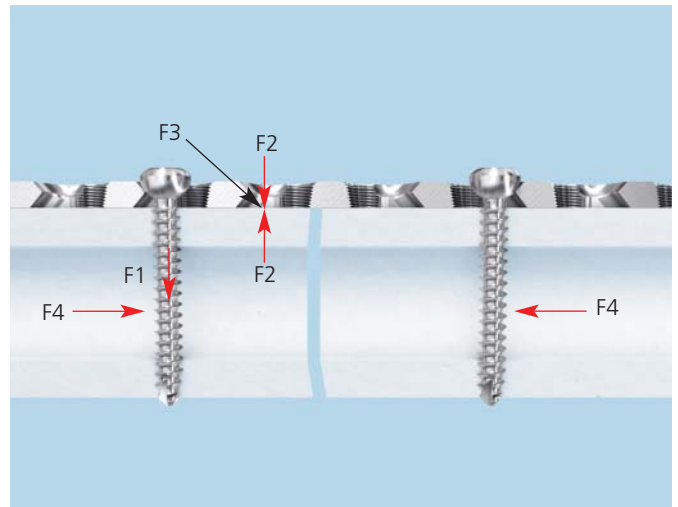

Primary loss of reduction

In conventional plating, even though the bone fragments are correctly reduced prior to plate application, fracture dislocation will result if the plate does not fit the bone. In addition, if the lag screw is not seated perpendicular to the fracture line (e.g., spiral fracture of the distal tibia), shear forces will be introduced. These forces may cause loss of reduction.

Secondary loss of reduction

Under axial load, postoperative, secondary loss of reduction may occur by toggling of the screws. Since cortex screws do not lock to the plate, the screws cannot oppose the acting force and may loosen, or be pushed axially through the plate holes.

Blood supply to the bone

The periosteum is compressed under the plate area, reducing or even interrupting blood supply to the bone. The result is delayed bone healing due to temporary osteoporosis underneath the plate.

Osteoporosis

Due to compromised cortical structure, screws cannot be tightened sufficiently to obtain the compression needed to support the bone. This may cause loosening of the screws and loss of stability, and may jeopardize the reduction.

Standard plating achieves good results in:

- Good quality bone
- Fractures which are traditionally fixed with lag screws to achieve direct bone healing

Special attention must be paid to:

- Osteoporotic bone; during rehabilitation, the load should be kept to a minimum to prevent postoperative loss of reduction
- Multifragmentary fractures; the anatomic reduction may be accomplished at the expense of extensive soft tissue trauma and denudation

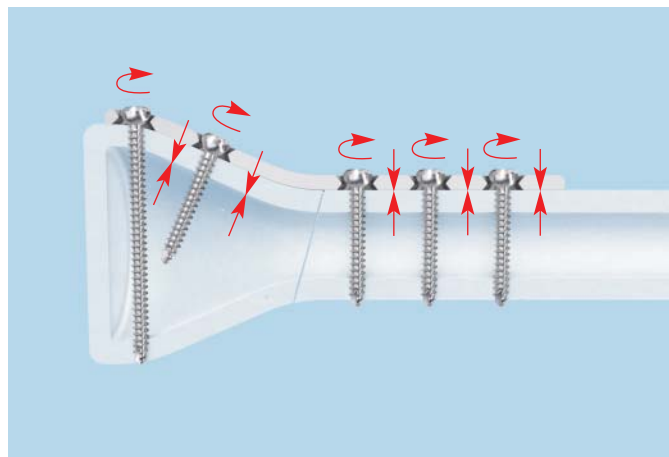
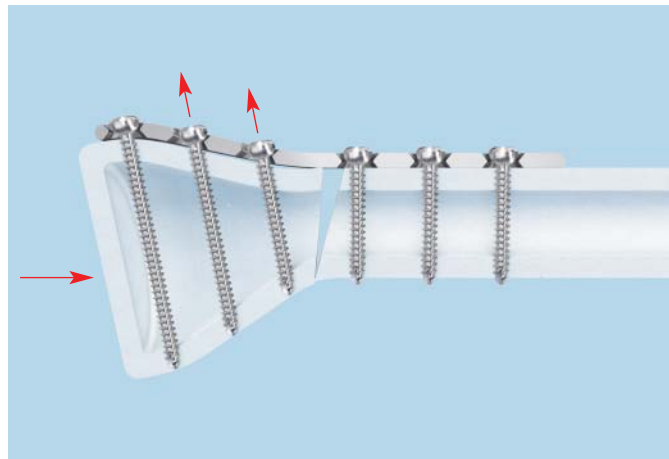

Bridge/locked plating using locking screws

- Screws lock to the plate, forming a fixed-angle construct
- Bone healing is achieved indirectly by callus formation when using locking screws exclusively

Maintenance of primary reduction

Once the locking screws engage the plate, no further tightening is possible. Therefore, the implant locks the bone segments in their relative positions regardless of degree of reduction.

Precontouring the plate minimizes the gap between the plate and the bone, but an exact fit is not necessary for implant stability. This feature is especially advantageous in minimally or less invasive plating techniques because these techniques do not allow exact contouring of the plate to the bone surface.

Stability under load

By locking the screws to the plate, the axial force is transmitted over the length of the plate. The risk of a secondary loss of the intraoperative reduction is reduced.

Blood supply to the bone

Locking the screw into the plate does not generate additional compression. Therefore, the periosteum will be protected and the blood supply to the bone preserved.

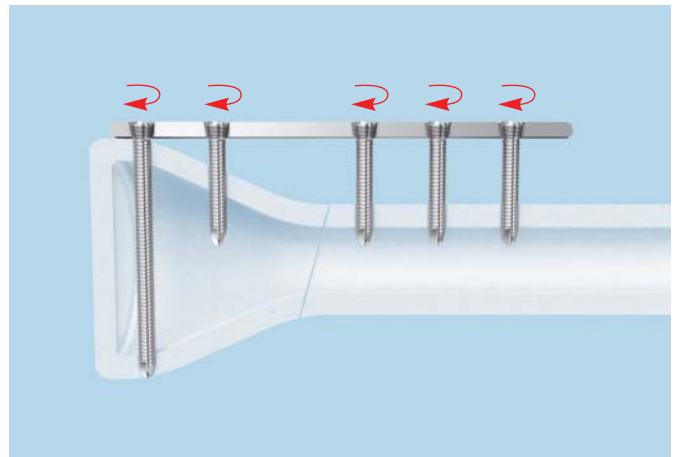

Combined internal fixation

The combination of conventional compression plating and locked plating techniques enhances plate osteosynthesis. The result is a combination hole or Combi hole that, depending on the indication, allows standard compression plating, locked/bridge plating or a combination of both.

Internal fixation using a combination of locking screws and standard screws

Note: If a combination of cortex and locking screws is used, a cortex screw should be inserted first to pull the plate to the bone.

If locking screws (1) have been used to fix a plate to a fragment, subsequent insertion of a standard screw (2) in the same fragment without loosening and retightening the locking screw is NOT RECOMMENDED.

Note: If a locking screw is used first, care should be taken to ensure that the plate is held securely to the bone to avoid spinning of the plate about the bone.

Dynamic compression

Once the metaphyseal fragment has been fixed with locking screws, the fracture can be dynamically compressed using standard screws in the DCU portion of the Combi hole.

Locked and standard plating techniques

- First, use lag screws to anatomically reconstruct the joint surfaces
- The behavior of a locking screw is not the same as that of a lag screw. With the locked plating technique, the implant locks the bone segments in their relative positions regardless of how they are reduced
- A plate used as a locked/bridge plate does not produce any additional compression between the plate and the bone
- The unicortical insertion of a locking screw causes no loss of stability

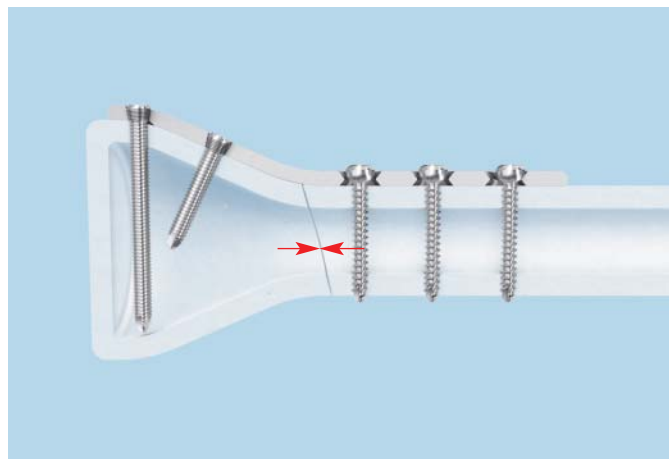
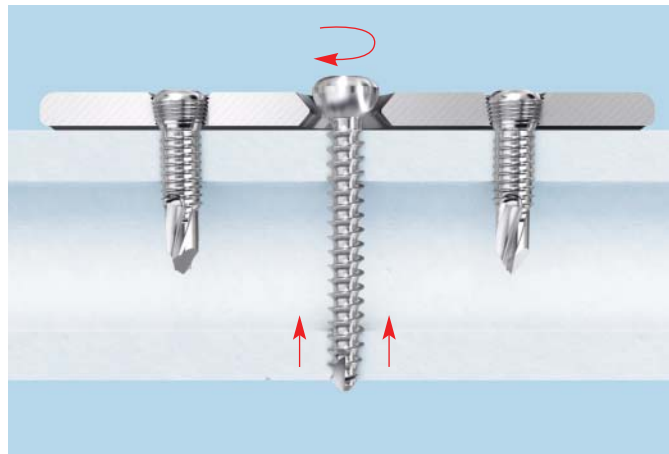
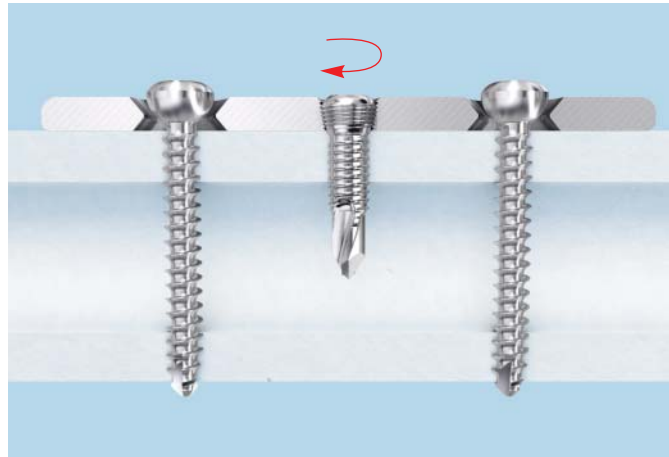

Preparation

1

Plate selection

Instrument

329.87, Bending Template (7, 9 or 12 holes)
329.89,
or
329.820

The plates are available in various lengths similar to the Synthes LC-DCP Small Fragment Set. If necessary, use a bending template to determine plate length.

2

Contouring

Use the bending instruments to contour the locking compression plate to the anatomy.

Notes: The plate holes have been designed to accept some degree of deformation. When bending the plate, place the bending irons on two consecutive holes. This ensures that the threaded holes will not be distorted. Significant distortion of the locking holes will reduce locking effectiveness. Please refer to the *AO Principles of Fracture Management*,⁴ and *AO Manual of Fracture Management – Internal Fixators*.⁵

4. Rüedi.
5. Wagner.

Reduction and Temporary Plate Placement

3

Reduction and temporary plate placement

Instruments

324.024 Push-Pull Reduction Sleeve

324.023 Threaded Plate Holder

or

324.031 Threaded Plate Holder, long

The plate may be temporarily held in place with standard plate holding forceps or the push-pull reduction device.

Note: The middle of the plate should be positioned over the fracture site if compression of the fracture fragments is desired.

The push-pull reduction device is designed to temporarily hold the plate to the bone through a plate hole. The device is self-drilling and connects with the Synthes quick connection for power insertion. Insert into near cortex only. After power insertion, turn the collet clockwise until it pulls the plate securely to the bone.

Note: Care should be taken to avoid inserting this device in a hole that will be needed immediately for plate fixation. However, the device may be removed and a screw inserted through the same plate hole.

A threaded plate holder can also be used as an aid to position the plate on the bone. The plate holder may also function as an insertion handle for use with minimally invasive plating techniques.



324.024

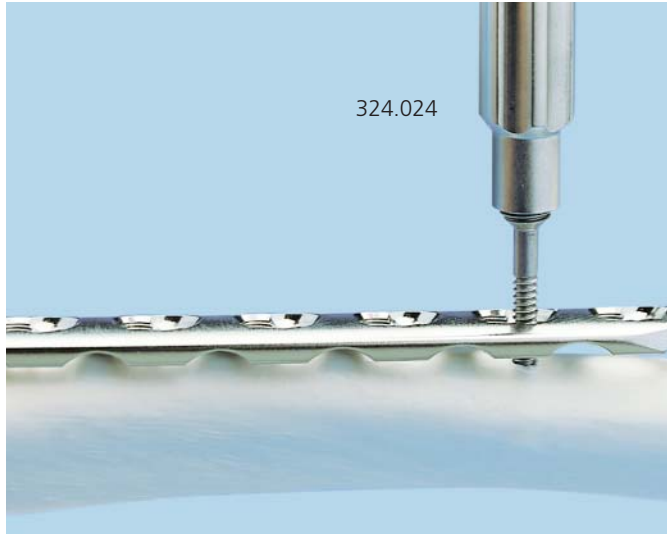

324.024



324.031

Screw Insertion

4

Screw insertion

Determine whether standard 3.5 mm cortex screws, 4.0 mm cancellous screws or 3.5 mm locking screws will be used for fixation. A combination of all may be used.

Important: 2.7 mm cortex screws can only be used in the round holes of the right-angle T-plates, oblique T-plates, and one-third tubular plates.

Note: If a combination of cortex, cancellous and locking screws is used, a standard screw should be used first to pull the plate to the bone.

Warning: If a locking screw is used first, care should be taken to ensure that the plate is held securely to the bone to avoid spinning of the plate about the bone.

4

Screw Insertion continued

Instrument

323.36 3.5 mm Universal Drill Guide

Insertion of a cortex or cancellous bone screw

Use the 3.5 mm universal drill guide for an eccentric (compression) or neutral (buttress) insertion of cortex screws.

Note: The 3.5 mm LC-DCP drill guide and the 3.5 mm DCP drill guide are NOT suitable for use with LCP plates.

Neutral insertion of a standard screw

When pressing the universal drill guide into the DCU portion of the LCP plate, it will center itself and allow neutral predrilling.

Dynamic compression, eccentric insertion of a cortex screw

To drill a hole for dynamic compression, place the universal drill guide eccentrically at the edge of the DCU portion of the LCP plate hole, without applying pressure. Tightening of the cortex screws will result in dynamic compression corresponding to that of the LC-DCP.



Instruments

310.288	2.8 mm Drill Bit
312.648	2.8 mm Threaded Drill Guide
319.01	Depth Gauge

Insertion of 3.5 mm locking screws

Reminder: The locking screw is not a lag screw. Use standard screws when requiring a precise anatomical reduction (e.g., joint surfaces) or interfragmentary compression. Before inserting the first locking screw, perform anatomical reduction and fix the fracture with lag screws, if necessary. After the insertion of locking screws, an anatomical reduction will no longer be possible without loosening the locking screw.

Screw the 2.8 mm threaded drill guide into an LCP plate hole until fully seated (Figure 1).

Note: Since the direction of a locking screw is determined by plate design, final screw position may be verified with a K-wire prior to insertion. This becomes especially important when the plate has been contoured or applied in metaphyseal regions around joint surfaces (refer to "Screw placement verification" on page 17).

Warning: Do not try to bend the plate using the threaded drill guide because damage may occur to the plate hole threads.

Use the 2.8 mm drill bit to drill the desired depth (Figure 2).

Remove the threaded drill guide and use the depth gauge to determine screw length (Figure 3).

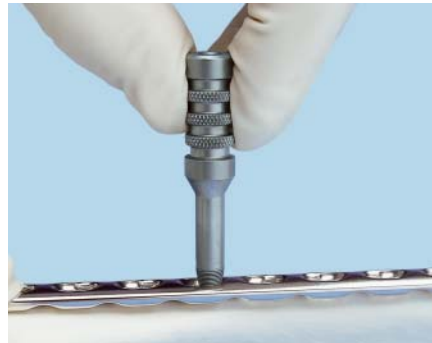

Figure 1



Figure 2



Figure 3

4

Screw Insertion continued

Instruments

314.115	StarDrive Screwdriver, T15
314.116	StarDrive Screwdriver Shaft, T15
511.770*	Torque Limiting Attachment, 1.5 Nm or
511.773	Torque Limiting Attachment, 1.5 Nm, quick coupling

Insert the locking screw under power using a torque limiting attachment and StarDrive screwdriver shaft.

Note: Recheck each locking screw before closing to verify that the screws are securely locked to the plate. Screwheads must be flush with the plate in the locked position before they can be considered fully seated.

Warning: Always use a torque limiting attachment (TLA) when using power to insert locking screws.

Alternative method of locking screw insertion

Use the StarDrive screwdriver to manually insert the appropriate length locking screw. Carefully tighten the locking screw, as excessive force is not necessary to produce effective screw-to-plate locking.



Incorrect

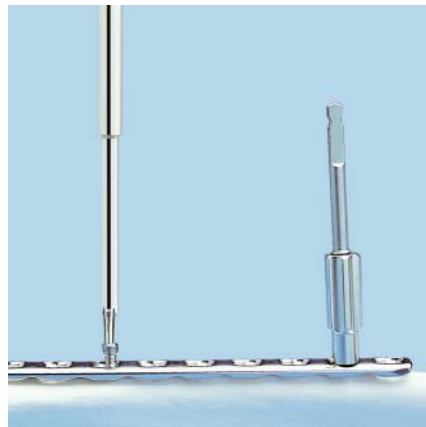

* Also available

Screw Placement Verification

5

Screw placement verification

Instruments

292.71	1.6 mm Kirschner Wire with Thread
323.023	1.6 mm Wire Sleeve
323.025	Direct Measuring Device

Since the direction of a locking screw is determined by plate design, final screw position may be verified with a K-wire prior to insertion. This becomes especially important when the plate has been contoured or applied in metaphyseal regions around joint surfaces.

With the 2.8 mm threaded drill guide in place, insert the 1.6 mm wire sleeve into the threaded drill guide (Figure 1).

Insert a threaded 1.6 mm Kirschner wire through the wire sleeve and drill to the desired depth (Figure 2).

- Verify K-wire placement under image intensification to determine if final screw placement is acceptable (Figure 3).

Important: The K-wire position represents the final position of the locking screw. Confirm that the K-wire does not enter the joint.

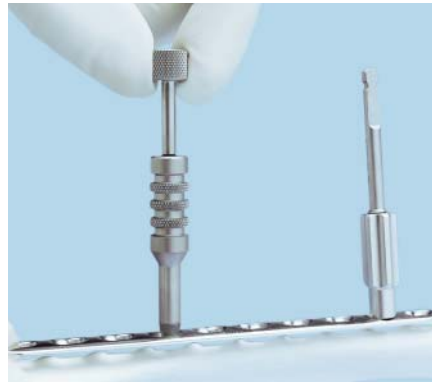

Figure 1



Figure 2



Figure 3

5

Screw placement verification continued

Measurement may be taken by sliding the tapered end of the direct measuring device over the K-wire down to the wire sleeve (Figure 4).

Remove the direct measuring device, K-wire and 1.6 mm wire sleeve, leaving the threaded drill guide intact.

Use the 2.8 mm drill bit to drill the near cortex. Remove the threaded drill guide. Insert the appropriate length locking screw.

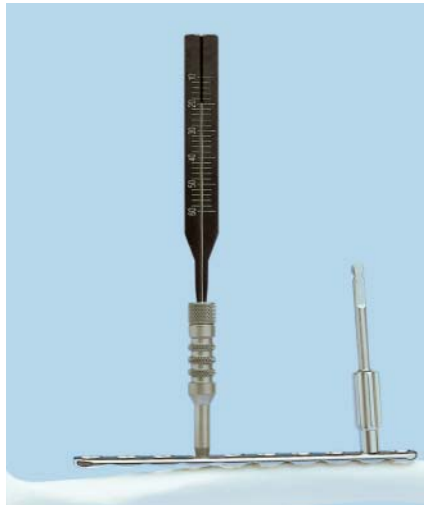

Figure 4

Postoperative Treatment and Implant Removal

Postoperative treatment

Postoperative treatment with locking compression plates does not differ from conventional internal fixation procedures.

Implant removal

To remove locking screws, unlock all screws from the plate; then remove the screws completely from the bone. This prevents simultaneous rotation of the plate when removing the last locking screw.

Screws

2.7 mm Cortex Screws, self-tapping

- May be used in the distal locking holes
- Compress the plate to the bone
- Fully threaded shaft
- Available in stainless steel and titanium



202.810–202.855



402.810–402.855

3.5 mm Shaft Screws

- May be used in the DCU portion of the Combi hole in the plate shaft or in round locking holes
- Compress the plate to the bone or create axial compression
- Partially threaded shaft
- Available in stainless steel and titanium alloy*



204.216–204.238



404.216–404.238

3.5 mm Cortex Screws, self-tapping

- May be used in the DCU portion of the Combi holes in the plate shaft or in round locking holes
- Compress the plate to the bone or create axial compression
- Fully threaded shaft
- Available in stainless steel and titanium



204.810–204.860



404.810–404.855

3.5 mm Cortex Screws, self-tapping, with T15 StarDrive recess

- May be used in the DCU portion of the Combi holes in the plate shaft or in round locking holes
- Compress the plate to the bone or create axial compression
- Fully threaded shaft
- Available in stainless steel and titanium



02.200.010–02.200.060

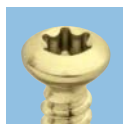

04.200.010–04.200.060

3.5 mm Locking Screws, self-tapping, with StarDrive recess

- Used in the locking portion of the Combi holes or in round locking holes
- Create a locked, fixed-angle screw/plate construct
- Self-tapping tip
- Fully threaded shaft
- Available in stainless steel and titanium alloy*



212.101–212.124



412.101–412.124

* Ti-6Al-7Nb

4.0 mm Cancellous Bone Screws

- May be used in the DCU portion of the Combi holes, in the plate shaft or in round locking holes
- Compress the plate to the bone or create axial compression
- Fully or partially threaded shaft
- Available in stainless steel and titanium



206.010-206.060



207.010-207.050



406.010-406.060



407.010-407.050

Plates

3.5 mm LCP Plates

- Available with 2–16 Combi holes (33 mm–215 mm lengths), 18 (241 mm), 20 mm (267 mm) and 22 Combi holes (293 mm)
- Limited-contact plate design
- Tapered plate ends for submuscular plate insertion
- Available in stainless steel and titanium



223.581

3.5 mm LCP T-Plates, 3 holes head, right angle

- Available with 3–8 shaft holes (50 mm–97 mm lengths)
- Plate contains Combi holes in the shaft, locking holes in the head
- Available in stainless steel and titanium



241.171

3.5 mm LCP T-Plates, 4 holes head, right angle

- Available with 3–8 shaft holes (50 mm–100 mm lengths)
- Plate contains Combi holes in the shaft, locking holes in the head
- Available in stainless steel and titanium



241.172

3.5 mm LCP T-Plates, 3 holes head, oblique right

- Available with 3–8 shaft holes (52 mm–107 mm lengths)
- Plate contains Combi holes in the shaft, locking holes in the head
- Available in stainless steel and titanium



241.081

3.5 mm LCP T-Plates, 3 holes head, oblique left

- Available with 3–8 shaft holes (52 mm–107 mm lengths)
- Plate contains Combi holes in the shaft, locking holes in the head
- Available in stainless steel and titanium



241.981

LCP One-Third Tubular Plates, with collar

- Available with 3–10 holes (33 mm–117 mm lengths) and 12 holes (141 mm)
- Plate contains only locking holes, that accept 3.5 mm locking screws, 3.5 mm cortex screws, and 2.7 mm cortex screws
- Available in stainless steel and titanium



241.401

3.5 mm LCP Reconstruction Plates

- Available with 4 – 14 Combi holes (56 mm – 196 mm lengths), 16 (224 mm), 18 (252 mm), 20 (280 mm) and 22 Combi holes (308 mm)
- Available in stainless steel and titanium



245.081

3.5 mm LCP Proximal Humerus Plates

- Distal shaft consists of three or five Combi holes in the shaft, including one elongated Combi hole to aid in plate positioning
- Holes accept 3.5 mm locking screws in the threaded portion, and 3.5 mm cortex screws, 4.0 mm cortex screws, and 4.0 mm cancellous bone screws in the compression portion
- Available in stainless steel and titanium

Longer lengths are also available in the 3.5 mm LCP Long Proximal Humerus Plate Implant Sets: Stainless steel (01.109.602) and Titanium (01.109.604).

Refer to the *3.5 mm LCP Proximal Humerus Plate Technique Guide*.



3.5 mm LCP Curved Reconstruction Plates

- Available with 4 – 18 Combi holes in 2-hole increments
- Available in stainless steel only



245.401

Instruments

310.21 2.0 mm Drill Bit, quick coupling, 125 mm



310.25 2.5 mm Drill Bit, quick coupling, 110 mm, gold



310.288 2.8 mm Drill Bit, quick coupling, 165 mm



310.35 3.5 mm Drill Bit, quick coupling, 110 mm



310.89 Countersink, for 3.5 mm Cortex and 4.0 mm Cancellous Bone Screws



311.32 Tap for 3.5 mm Cortex Screws, gold, 110 mm



311.34 Tap for 4.0 mm Cancellous Bone Screws, 110 mm



311.43 Handle, with quick coupling



312.20 2.0 mm Parallel Drill Guide and Drill Sleeve



312.30 3.5 mm/2.5 mm Insert Drill Sleeve



312.648 2.8 mm Threaded Drill Guide



314.02 Small Hexagonal Screwdriver with Holding Sleeve



314.03 Small Hexagonal Screwdriver Shaft, quick coupling



314.115 StarDrive Screwdriver, T15, self-retaining



314.116 StarDrive Screwdriver Shaft, T15, self-retaining, quick coupling



315.28 2.7 mm Three-Fluted Drill Bit, quick coupling, 125 mm



319.01 Depth Gauge



319.39 Sharp Hook



319.97 Screw Forceps



323.023 1.6 mm Wire Sleeve



323.025 Direct Measuring Device



323.050 Insertion Guide



323.053 3.5 mm Locking Screw Sleeve



323.054 2.8 mm Drill Sleeve



323.055 1.6 mm Wire Sleeve



323.26 2.7 mm Universal Drill Guide



323.36 3.5 mm Universal Drill Guide



324.023 Threaded Plate Holder



324.024 Push-Pull Reduction Device



324.031 Threaded Plate Holder, long



329.04 Bending Iron, for 2.7 mm and 3.5 mm plates
(used with 329.05)



329.05 Bending Iron, for 2.7 mm and 3.5 mm plates
(used with 329.04)



329.07 Bending Iron, for 2.7 mm and 3.5 mm
Reconstruction Plates



329.87 Bending Templates

7 holes

329.89 9 holes

329.820 12 holes



391.82 Wire-Bending Pliers



392.00 Bending Iron, for 1.25 mm, 1.6 mm and 2.0 mm Kirschner Wires



398.40 Reduction Forceps with points, narrow, ratchet



398.41 Reduction Forceps with points, broad, ratchet



398.80* Self-Centering Bone Forceps, extra small serrated jaw, speed lock



398.811 Plate Holding Forceps with swivel foot



* Included in the Small Fragment Instrument and Titanium Implant Set (145.434)

399.091** Bone Holding Forceps, soft ratchet,
for plate widths up to 9 mm



399.19 Hohmann Retractor, 8 mm width, small



399.36 Periosteal Elevator, 6 mm width, curved blade,
round edge



399.49 Hohmann Retractor, for small fragments,
15 mm width



399.99 Reduction Forceps, with serrated jaw, ratchet



511.773 Torque Limiting Attachment, 1.5 Nm,
quick coupling



** Included in the Small Fragment Instrument and Implant Set (105.434)

Small Fragment LCP Instrument and Implant Sets

Stainless Steel (01.212.005, 01.212.006, 01.212.007, 105.434)
and Titanium (01.212.008, 01.212.009, 145.434)

Sets

- 01.212.005 Small Fragment LCP Instrument and Implant Set, with 3.5 mm StarDrive cortex screws
- 01.212.006 Small Fragment LCP Instrument and Implant Set, with 3.5 mm HexDrive cortex screws
- 01.212.007 Small Fragment LCP Instrument and Implant Set, with 4.0 mm Cannulated Screws
- 01.212.008 Small Fragment LCP Instrument and Titanium Implant Set, with 3.5 mm StarDrive cortex screws
- 01.212.009 Small Fragment LCP Instrument and Titanium Implant Set, with 3.5 mm HexDrive cortex screws
- 105.434 Small Fragment LCP Instrument and Implant Set
- 145.434 Small Fragment LCP Instrument and Titanium Implant Set

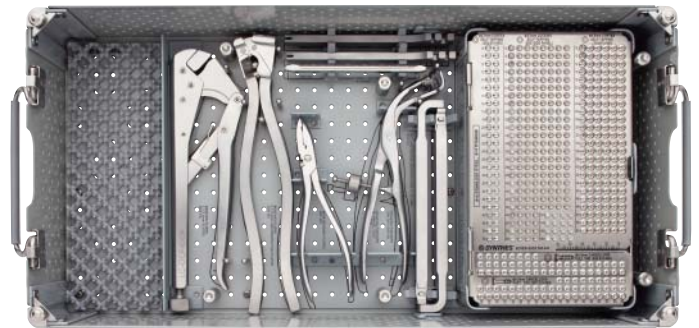

Graphic Cases

- 60.212.005 Small Fragment LCP Instrument and Implant Set Graphic Case, without screw rack (screw racks ordered separately)
- 690.347 Small Fragment LCP Instrument and Implant Set Graphic Case (includes screw rack 690.347.30)
- 690.410 Small Fragment LCP Instrument and Titanium Implant Set Graphic Case (includes screw rack 690.411)

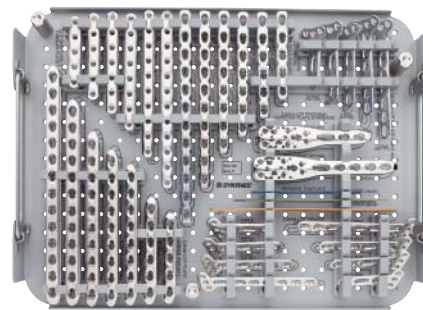

Screw Racks

- 690.347.30 Screw Rack (for Graphic Case 690.347)
- 690.411 Screw Rack (for Graphic Case 690.410)
- 691.383 Small Fragment LCP Cannulated Screw Rack, nylon coated (for set 01.212.007)
- 691.387 Small Fragment LCP Cannulated Screw Instrument Tray, nylon coated (for set 01.212.007)
- 691.443 Small Fragment LCP Screw Rack, for 3.5 mm StarDrive cortex screws, nylon coated (for sets 01.212.005 and 01.212.008)
- 691.444 Small Fragment LCP Screw Rack, for 3.5 mm hex drive cortex screws, nylon coated (for sets 01.212.006 and 01.212.009)

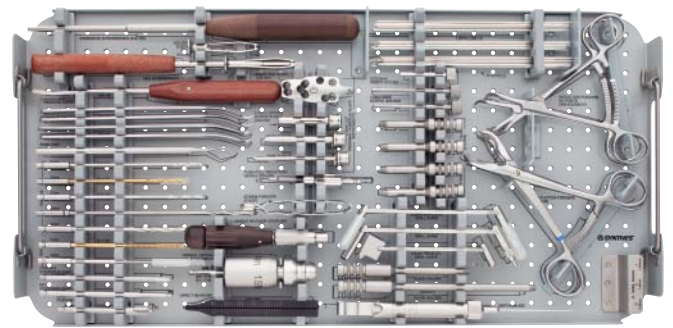

691.387

Note: For additional information, please refer to package insert.

For detailed cleaning and sterilization instructions, please refer to http://www.synthes.com/sites/NA/MedicalCommunity/Pages/Cleaning_and_Sterilization.aspx or to the below listed inserts which will be included in the shipping container:

- Processing Synthes Reusable Medical Devices—Instruments, Instrument Trays and Graphic Cases—DJ1305
- Processing Non-sterile Synthes Implants—DJ1304

Small Fragment LCP Instrument and Implant Sets

Stainless Steel (01.212.005, 01.212.006, 01.212.007, 105.434)

and Titanium (01.212.008, 01.212.009, 145.434) *continued*

Instruments

310.21	2.0 mm Drill Bit, quick coupling, 125 mm, 2 ea.	319.97	Screw Forceps
310.25	2.5 mm Drill Bit, quick coupling, 110 mm, gold, 2 ea.	323.023	1.6 mm Wire Sleeve, 2 ea.
310.288	2.8 mm Drill Bit, quick coupling, 165 mm, 2 ea.	323.025	Direct Measuring Device
310.35	3.5 mm Drill Bit, quick coupling, 110 mm, 2 ea.	323.050	Insertion Guide
310.67†	2.7 mm Cannulated Drill Bit, quick coupling, 160 mm	323.053	3.5 mm Locking Screw Sleeve, 2 ea.
310.86†	Cannulated Countersink, for 3.5 mm and 4.0 mm Cannulated Screws	323.054	2.8 mm Drill Sleeve, 2 ea.
310.89	Countersink, for 3.5 mm Cortex and 4.0 mm Cancellous Bone Screws	323.055	1.6 mm Wire Sleeve, 2 ea.
311.32	Tap for 3.5 mm Cortex Screws, gold, 110 mm, 2 ea.	323.26	2.7 mm Universal Drill Guide
311.34	Tap for 4.0 mm Cancellous Bone Screws, 110 mm, 2 ea.	323.36	3.5 mm Universal Drill Guide
311.43	Handle, with quick coupling	324.023	Threaded Plate Holder
311.63†	Cannulated Tap for 4.0 mm Cannulated Screws, 147 mm	324.024	Push-Pull Reduction Device
312.20	2.0 mm Parallel Drill Guide and Drill Sleeve	324.031	Threaded Plate Holder, long
312.30	3.5 mm/2.5 mm Insert Drill Sleeve	329.04	Bending Iron, for 2.7 mm and 3.5 mm plates
312.35†	2.7 mm/1.25 mm Double Drill Sleeve	329.05	Bending Iron, for 2.7 mm and 3.5 mm plates
312.648	2.8 mm Threaded Drill Guide, 4 ea.	329.07	Bending Iron, for 2.7 mm and 3.5 mm Reconstruction Plates, 2 ea.
314.02	Small Hexagonal Screwdriver with Holding Sleeve	329.820	Bending Template, 12 holes
314.03	Small Hexagonal Screwdriver Shaft, quick coupling	329.87	Bending Template, 7 holes
314.08†	Holding Sleeve	329.89	Bending Template, 9 holes
314.115	StarDrive Screwdriver, T15, self-retaining	391.82	Wire-Bending Pliers, 160 mm
314.116	StarDrive Screwdriver Shaft, T15, self-retaining, quick coupling	392.00	Bending Iron, for 1.25 mm, 1.6 mm and 2.0 mm Kirschner Wires
314.29†	Cannulated Hexagonal Screwdriver	398.40	Reduction Forceps with points, narrow, ratchet
315.28	2.7 mm Three-Fluted Drill Bit, quick coupling, 125 mm, 2 ea.	398.41	Reduction Forceps with points, broad, ratchet
319.01	Depth Gauge	398.80*	Self-Centering Bone Forceps, 190 mm length extra small serrated jaw, speed lock
319.15†	Cannulated Screw Measuring Device for 3.5 mm and 4.0 mm cannulated screws	398.811	Plate Holding Forceps with swivel foot
319.25†	1.35 mm Cleaning Brush	399.091**	Bone Holding Forceps, soft ratchet, for plate widths up to 9 mm
319.38†	1.25 mm Cleaning Stylet	399.19	Hohmann Retractor, 8 mm width, small, 2 ea.
319.39	Sharp Hook	399.36	Periosteal Elevator, 6 mm width, curved blade, round edge
		399.49	Hohmann Retractor, for small fragments, 15 mm width, 2 ea.
		399.99	Reduction Forceps, with serrated jaw, ratchet, 2 ea.
		511.773	Torque Limiting Attachment, 1.5 Nm, quick coupling
		900.722†	1.25 mm Threaded Guide Wire, 150 mm, 20 ea.

* Included in titanium sets 145.434, 01.212.008, and 01.212.009

† Included in stainless steel set 01.212.007

**Included in stainless steel sets 105.434, 01.212.005, 01.212.006 and 01.212.007

Implants (included in all sets)

3.5 mm LCP Plates, 2 ea.

Stainless Steel	Titanium	Holes	Length (mm)
223.551	423.551	5	72
223.561	423.561	6	85
223.581	423.581	8	111
223.591	423.591	9	124
223.601	423.601	10	137
223.621	423.621	12	163
223.641	423.641	14	189

3.5 mm LCP T-Plates, 3 holes head, oblique right

Stainless Steel	Titanium	Shaft Holes	Length (mm)
241.031	441.031	3	52
241.041	441.041	4	63
241.051	441.051	5	74
241.071	441.071	7	96

3.5 mm LCP T-Plates, 4 holes head, right angle

Stainless Steel	Titanium	Shaft Holes	Length (mm)
241.141	441.141	4	56
241.161	441.161	6	78

3.5 mm LCP T-Plates, 3 holes head, right angle

Stainless Steel	Titanium	Shaft Holes	Length (mm)
241.131	441.131	3	50
241.151	441.151	5	67
241.171	441.171	7	87

LCP One-Third Tubular Plates, with collar

Stainless Steel	Titanium	Holes	Length (mm)	Qty.
241.351	441.351	5	57	2
241.361	441.361	6	69	2
241.371	441.371	7	81	2
241.381	441.381	8	93	1
241.401	441.401	10	117	1
241.421	441.421	12	141	1

3.5 mm LCP Proximal Humerus Plates, 6 holes head

Stainless Steel	Titanium	Shaft Holes	Length (mm)
241.901	441.901	3	90
241.903	441.903	5	114

3.5 mm LCP T-Plates, 3 holes head, oblique left

Stainless Steel	Titanium	Shaft Holes	Length (mm)
241.931	441.931	3	52
241.941	441.941	4	63
241.951	441.951	5	74
241.971	441.971	7	96

3.5 mm LCP Reconstruction Plates, 2 ea.

Stainless Steel	Titanium	Holes	Length (mm)
245.051	445.051	5	70
245.061	445.061	6	84
245.071	445.071	7	98
245.081	445.081	8	112
245.101	445.101	10	140
245.121	445.121	12	168

Stainless Steel Titanium

219.98	419.98	Washer, 7.0 mm, 6 ea.
292.12	492.12	1.25 mm Kirschner Wire, 150 mm, 1 pkg. of 10
292.20	492.20	2.0 mm Kirschner Wire, 150 mm, 1 pkg. of 10
292.71	292.71 [†]	1.6 mm Kirschner Wire with Thread, 150 mm, 5 mm thread length, 1 pkg. of 10

[†] Stainless steel K-wire provided in all sets

Small Fragment LCP Instrument and Implant Sets

Stainless Steel (01.212.005, 01.212.006, 01.212.007, 105.434)

and Titanium (01.212.008, 01.212.009, 145.434) continued

Screws in Small Fragment LCP Sets 01.212.005, 01.212.006, 01.212.008 and 01.212.009

2.7 mm Cortex Screws, self-tapping

Stainless Steel	Titanium	Length (mm)	Qty.
202.810	402.810	10	4
202.812	402.812	12	4
202.814	402.814	14	4
202.816	402.816	16	4
202.818	402.818	18	4
202.820	402.820	20	4
202.822	402.822	22	2
202.824	402.824	24	2
202.826	402.826	26	2
202.828	402.828	28	2
202.830	402.830	30	2
202.832	402.832	32	2
202.834	402.834	34	2
202.836	402.836	36	2
202.838	402.838	38	2
202.840	402.840	40	2
202.845	402.845	45	2
202.850	402.850	50	2
202.855	402.855	55	2

4.0 mm Cancellous Bone Screws, fully threaded

Stainless Steel	Titanium	Length (mm)	Qty.
206.010	406.010	10	3
206.012	406.012	12	3
206.014	406.014	14	3
206.016	406.016	16	3
206.018	406.018	18	3
206.020	406.020	20	3
206.022	406.022	22	3
206.024	406.024	24	3
206.026	406.026	26	2
206.028	406.028	28	2
206.030	406.030	30	2
206.035	406.035	35	2
206.040	406.040	40	4
206.045	406.045	45	4
206.050	406.050	50	2
206.055	406.055	55	2
206.060	406.060	60	2

4.0 mm Cancellous Bone Screws, partially threaded

Stainless Steel	Titanium	Length (mm)	Qty.
207.010	407.010	10	2
207.012	407.012	12	2
207.014	407.014	14	2
207.016	407.016	16	2
207.018	407.018	18	2
207.020	407.020	20	2
207.022	407.022	22	2
207.024	407.024	24	2
207.026	407.026	26	2
207.028	407.028	28	2
207.030	407.030	30	3
207.035	407.035	35	3
207.040	407.040	40	6
207.045	407.045	45	6
207.050	407.050	50	3
207.055	407.055	55	3
207.060	407.060	60	3

Screws in Small Fragment LCP Sets 01.212.005, 01.212.006, 01.212.008 and 01.212.009 *continued*

3.5 mm Locking Screws, self-tapping, with StarDrive recess

Stainless steel	Titanium	Length (mm)	Qty.
212.101	412.101	10	8
212.102	412.102	12	8
212.103	412.103	14	8
212.104	412.104	16	8
212.105	412.105	18	8
212.106	412.106	20	8
212.107	412.107	22	8
212.108	412.108	24	8
212.109	412.109	26	8
212.110	412.110	28	8
212.111	412.111	30	8
212.112	412.112	32	8
212.113	412.113	34	8
212.114	412.114	35	8
212.115	412.115	36	8
212.116	412.116	38	8
212.117	412.117	40	8
212.118	412.118	42	8
212.134	412.134	44	8
212.119	412.119	45	8
212.136	412.136	46	8
212.120	412.120	48	4
212.121	412.121	50	4
212.122	412.122	52	4
02.212.054	04.212.054	54	4
212.123	412.123	55	4
02.212.056	04.212.056	56	4
02.212.058	04.212.058	58	4
212.124	412.124	60	4

Screws in Small Fragment LCP Sets 01.212.005 and 01.212.008

3.5 mm Cortex Screws, self-tapping, with T15 StarDrive recess, 6 ea.

Stainless Steel	Titanium	Length (mm)
02.200.010	04.200.010	10
02.200.012	04.200.012	12
02.200.014	04.200.014	14
02.200.016	04.200.016	16
02.200.018	04.200.018	18
02.200.020	04.200.020	20
02.200.022	04.200.022	22
02.200.024	04.200.024	24
02.200.026	04.200.026	26
02.200.028	04.200.028	28
02.200.030	04.200.030	30
02.200.032	04.200.032	32
02.200.034	04.200.034	34
02.200.036	04.200.036	36
02.200.038	04.200.038	38
02.200.040	04.200.040	40
02.200.042	04.200.042	42
02.200.044	04.200.044	44
02.200.045	04.200.045	45
02.200.046	04.200.046	46
02.200.048	04.200.048	48
02.200.050	04.200.050	50
02.200.055	04.200.055	55
02.200.060	04.200.060	60

Small Fragment LCP Instrument and Implant Sets

Stainless Steel (01.212.005, 01.212.006, 01.212.007, 105.434)

and Titanium (01.212.008, 01.212.009, 145.434) continued

Screws in Small Fragment LCP Sets 01.212.006, 01.212.007 (stainless steel only) and 01.212.009

3.5 mm Cortex Screws, self-tapping, with hex recess, 6 ea.

Stainless Steel	Titanium	Length (mm)
204.810	404.810	10
204.812	404.812	12
204.814	404.814	14
204.816	404.816	16
204.818	404.818	18
204.820	404.820	20
204.822	404.822	22
204.824	404.824	24
204.826	404.826	26
204.828	404.828	28
204.830	404.830	30
204.832	404.832	32
204.834	404.834	34
204.836	404.836	36
204.838	404.838	38
204.840	404.840	40
204.842	–	42
204.844	–	44
204.845*	404.845	45
204.846	–	46
204.848	–	48
204.850	404.850	50
204.855	404.855	55
204.860	–	60

Screws in Small Fragment LCP Set 01.212.007

4.0 mm Cannulated Screws, short thread

	Length (mm)	Qty.
207.610	10	2
207.612	12	2
207.614	14	2
207.616	16	2
207.618	18	2
207.620	20	2
207.622	22	2
207.624	24	2
207.626	26	2
207.628	28	2

* Not included in set 01.212.007

Screws in Small Fragment LCP Set 01.212.007 continued

4.0 mm Cannulated Screws, short thread

	Length (mm)	Qty.
207.630	30	2
207.632	32	2
207.634	34	2
207.636	36	2
207.638	38	2
207.640	40	2
207.642	42	2
207.644	44	2
207.646	46	2
207.648	48	2
207.650	50	2
207.652	52	2
207.654	54	2
207.656	56	2
207.658	58	2
207.660	60	2
207.662	62	2
207.664	64	2
207.668	68	2
207.672	72	2

4.0 mm Cancellous Bone Screws, partially threaded

	Length (mm)	Qty.
207.010	10	2
207.012	12	2
207.014	14	2
207.016	16	2
207.018	18	2
207.020	20	2
207.022	22	2
207.024	24	2
207.026	26	2
207.028	28	2
207.030	30	2
207.035	35	2
207.040	40	4
207.045	45	4
207.050	50	2
207.055	55	2
207.060	60	2

Screws in Small Fragment LCP Set 01.212.007 continued

2.7 mm Cortex Screws, self-tapping

	Length (mm)	Qty.
202.810	10	2
202.812	12	2
202.814	14	4
202.816	16	4
202.818	18	4
202.820	20	4
202.822	22	2
202.824	24	2
202.826	26	2
202.828	28	2
202.830	30	2
202.832	32	2
202.834	34	2
202.836	36	2
202.838	38	2
202.840	40	2
202.845	45	2
202.850	50	2
202.855	55	2

4.0 mm Cancellous Bone Screws, fully threaded

	Length (mm)	Qty.
206.010	10	2
206.012	12	2
206.014	14	2
206.016	16	3
206.018	18	3
206.020	20	4
206.022	22	4
206.024	24	4
206.026	26	4
206.028	28	4
206.030	30	4
206.035	35	2
206.040	40	4
206.045	45	4
206.050	50	2
206.055	55	2
206.060	60	2

3.5 mm Locking Screws, self-tapping, with StarDrive recess

	Length (mm)	Qty.
212.101	10	6
212.102	12	6
212.103	14	6
212.104	16	6
212.105	18	6
212.106	20	6
212.107	22	6
212.108	24	6
212.109	26	6
212.110	28	6
212.111	30	6
212.112	32	6
212.113	34	6
212.115	36	6
212.116	38	6
212.117	40	6
212.118	42	6
212.134	44	6
212.136	46	6
212.120	48	6
212.121	50	6
212.122	52	6
02.212.054	54	6
02.212.056	56	5
02.212.058	58	5
212.124	60	6

Small Fragment LCP Instrument and Implant Set

Stainless Steel (01.212.005, 01.212.006, 01.212.007, 105.434)

and Titanium (01.212.008, 01.212.009, 145.434) continued

Screws in Small Fragment LCP Sets 105.434 and 145.434

2.7 mm Cortex Screws, self-tapping

Stainless Steel	Titanium	Length (mm)	Qty.
202.810	402.810	10	3
202.812	402.812	12	3
202.814	402.814	14	3
202.816	402.816	16	3
202.818	402.818	18	3
202.820	402.820	20	3
202.822	402.822	22	3
202.824	402.824	24	3
202.826	402.826	26	3
202.828	402.828	28	3
202.830	402.830	30	3
202.832	402.832	32	3
202.834	402.834	34	3
202.836	402.836	36	3
202.838	402.838	38	3
202.840	402.840	40	3
202.845	402.845	45	3
202.850	402.850	50	3
202.855	402.855	55	3

3.5 mm Shaft Screws

Stainless Steel	Titanium	Length (mm)	Qty.
204.216	404.216	16	2
204.218	404.218	18	2
204.220	404.220	20	2
204.222	404.222	22	2
204.224	404.224	24	2
204.226	404.226	26	2
204.228	404.228	28	2
204.230	404.230	30	2
204.232	404.232	32	2
204.234	404.234	34	2
204.236	404.236	36	2
204.238	404.238	38	2

3.5 mm Cortex Screws, self-tapping (with hex recess)

Stainless Steel	Titanium	Length (mm)	Qty.
204.810	404.810	10	6
204.812	404.812	12	6
204.814	404.814	14	6
204.816	404.816	16	6
204.818	404.818	18	6
204.820	404.820	20	6
204.822	404.822	22	6
204.824	404.824	24	6
204.826	404.826	26	6
204.828	404.828	28	6
204.830	404.830	30	6
204.832	404.832	32	6
204.834	404.834	34	6
204.836	404.836	36	6
204.838	404.838	38	6
204.840	404.840	40	6
204.845	404.845	45	6
204.850	404.850	50	6
204.855	404.855	55	4
204.860	—	60	4

Screws in Small Fragment LCP Sets 105.434 and 145.434

continued

4.0 mm Cancellous Bone Screws, fully threaded

Stainless Steel	Titanium	Length (mm)	Qty.
206.010	406.010	10	4
206.012	406.012	12	4
206.014	406.014	14	8
206.016	406.016	16	8
206.018	406.018	18	8
206.020	406.020	20	8
206.022	406.022	22	4
206.024	406.024	24	4
206.026	406.026	26	4
206.028	406.028	28	4
206.030	406.030	30	4
206.035	406.035	35	4
206.040	406.040	40	4
206.045	406.045	45	4
206.050	406.050	50	4
206.055	406.055	55	4
206.060	406.060	60	4

4.0 mm Cancellous Bone Screws, partially threaded

Stainless Steel	Titanium	Length (mm)	Qty.
207.010	407.010	10	4
207.012	407.012	12	4
207.014	407.014	14	4
207.016	407.016	16	4
207.018	407.018	18	4
207.020	407.020	20	4
207.022	407.022	22	4
207.024	407.024	24	4
207.026	407.026	26	4
207.028	407.028	28	4
207.030	407.030	30	8
207.035	407.035	35	8
207.040	407.040	40	8
207.045	407.045	45	8
207.050	407.050	50	8

3.5 mm Locking Screws, self-tapping, with StarDrive recess

Stainless Steel	Titanium	Length (mm)	Qty.
212.101	412.101	10	5
212.102	412.102	12	5
212.103	412.103	14	5
212.104	412.104	16	5
212.105	412.105	18	5
212.106	412.106	20	5
212.107	412.107	22	5
212.108	412.108	24	5
212.109	412.109	26	5
212.110	412.110	28	5
212.111	412.111	30	5
212.112	412.112	32	5
212.113	412.113	34	5
212.115	412.115	36	5
212.116	412.116	38	5
212.117	412.117	40	4
212.119	412.119	45	4
212.121	412.121	50	4
212.123	412.123	55	4
212.124	412.124	60	4

Also Available

Sets		4.0 mm Cancellous Bone Screws, partially threaded			
01.109.602	3.5 mm LCP Long Proximal Humerus Plate Implant Set	Stainless Steel	Titanium	Length (mm)	
		207.065	407.065	65	
01.109.604	3.5 mm Titanium LCP Long Proximal Humerus Plate Implant Set	207.070	407.070	70	
		207.075	407.075	75	
105.436	Small Fragment LCP Instrument Set for Cannulated Screws	207.080	407.080	80	
		207.085	407.085	85	
		207.090	407.090	90	
		207.095	407.095	95	
		207.100	407.100	100	
Instruments		4.0 mm Titanium Cannulated Screws, short thread			
03.122.001	2.8 mm LCP Drill Guide, long, for 3.5 mm LCP Plates, for use with 03.122.002	Length (mm)		Length (mm)	
03.122.002	2.8 mm LCP Drill Bit, quick coupling, 248 mm/95 mm calibration, for use with 03.122.001	407.610	10	407.640	40
329.15	Bending Pliers, for 2.7 and 3.5 mm plates	407.614	12	407.644	42
329.29	Bending Pliers, for 2.7 and 3.5 mm Reconstruction Plates	407.614	14	407.644	44
511.770	Torque Limiting Attachment, 1.5 Nm	407.616	16	407.646	46
		407.618	18	407.648	48
		407.640	20	407.650	50
		407.644	22	407.652	52
		407.644	24	407.654	54
		407.646	26	407.656	56
		407.648	28	407.658	58
		407.630	30	407.660	60
		407.634	32	407.664	64
		407.634	34	407.668	68
		407.636	36	407.672	72
		407.638	38		
Implants		3.5 mm Locking Screws, self-tapping, with T15 StarDrive Recess (stainless steel only)			
3.5 mm Stainless Steel Cortex Screws, self-tapping, with hex recess (stainless steel only)		Length (mm)		Length (mm)	
204.865	65	204.890	90	212.125	65
204.870	70	204.895	95	212.126	70
204.875	75	204.900	100	212.127	75
204.880	80	204.905	105	212.128	80
204.885	85	204.910	110		
4.0 mm Cancellous Bone Screws, fully threaded					
Stainless Steel	Titanium	Length (mm)			
206.065	406.065	65			
206.070	406.070	70			
206.075	406.075	75			
206.080	406.080	80			
206.085	406.085	85			
206.090	406.090	90			
206.095	406.095	95			
206.100	406.100	100			

Implants continued

3.5 mm LCP Plates

Stainless Steel	Titanium	Holes	Length (mm)
223.521	423.521	2	33
223.531	423.531	3	46
223.541	423.541	4	59
223.571	423.571	7	98
223.611	423.611	11	150
223.631	423.631	13	176
223.651	423.651	15	202
223.661	423.661	16	215
223.671	423.671	18	241
223.681	423.681	20	267
223.691	423.691	22	293

3.5 mm LCP T-Plates, 3 holes head, oblique right

Stainless Steel	Titanium	Shaft Holes	Length (mm)
241.061	441.061	6	85
241.081	441.081	8	107

3.5 mm LCP T-Plates, 3 holes head, oblique left

Stainless Steel	Titanium	Shaft Holes	Length (mm)
241.961	441.961	6	85
241.981	441.981	8	107

3.5 mm LCP T-Plates, 3 holes head, right angle

Stainless Steel	Titanium	Shaft Holes	Length (mm)
241.142	441.142	4	57
241.162	441.162	6	77
241.181	441.181	8	97

3.5 mm LCP T-Plates, 4 holes head, right angle

Stainless Steel	Titanium	Shaft Holes	Length (mm)
241.132	441.132	3	50
241.152	441.152	5	67
241.172	441.172	7	89
241.182	441.182	8	100

LCP One-Third Tubular Plates, with collar

Stainless Steel	Titanium	Shaft Holes	Length (mm)
241.331	441.331	3	33
241.341	441.341	4	45
241.391	441.391	9	105

3.5 mm LCP Reconstruction Plates

Stainless Steel	Titanium	Shaft Holes	Length (mm)
245.041	445.041	4	56
245.091	445.091	9	126
245.111	445.111	11	154
245.131	445.131	13	182
245.141	445.141	14	196
245.161	445.161	16	224
245.181	445.181	18	252
245.201	445.201	20	280
245.221	445.221	22	308

3.5 mm LCP Curved Reconstruction Plates (stainless steel only)

	Shaft Holes	Length (mm)
245.341	4	55
245.361	6	82
245.381	8	106
245.401	10	129
245.421	12	149
245.441	14	166
245.461	16	180
245.481	18	190



Synthes (USA)
1302 Wrights Lane East
West Chester, PA 19380
Telephone: (610) 719-5000
To order: (800) 523-0322
Fax: (610) 251-9056

Synthes (Canada) Ltd.
2566 Meadowpine Boulevard
Mississauga, Ontario L5N 6P9
Telephone: (905) 567-0440
To order: (800) 668-1119
Fax: (905) 567-3185

www.synthes.com