

RFN-ADVANCED™

RETROGRADE FEMORAL NAILING SYSTEM

Surgical Technique

For Intramedullary Fixation of Distal Femur Fractures



Table of Contents

INTRODUCTION	The AO Principles of Fracture Management	2
	Indications	3
SURGICAL TECHNIQUE	Opening the Distal Femur	4
	Reaming (optional)	15
	Insert Nail	16
	Fixation Options	20
	Locking Screw Options	23
	Standard Locking	23
	Freehand Locking	30
	Locking Attachment Washer	36
	Condylar Nuts & Washers	51
	1. Nut-Over-Drill Bit Technique	54
	2. Nut-Over-Screw Technique	59
	Insert End Cap	64
IMPLANT REMOVAL (OPTIONAL)		66
PRODUCT INFORMATION	Implants	68
	Instruments	76
	Optional Instruments	82
MRI INFORMATION		84

 Image Intensifier Control

 Notes

 Precautions

 WARNINGS

For detailed cleaning and sterilization instructions, please refer to www.depuyorthos.com/hcp/cleaning-sterilization or sterilization instructions, if provided in the instructions for use.

For additional information please refer to the package insert or www.e-ifu.com.

The AO Principles of Fracture Management

Mission

The AO's mission is promoting excellence in patient care and outcomes in trauma and musculoskeletal disorders.

AO Principles^{1,2}

1.



Fracture reduction and fixation to restore anatomical relationships.

2.

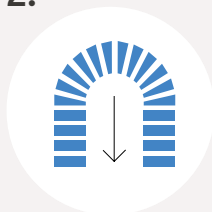

Fracture fixation providing absolute or relative stability, as required by the “personality” of the fracture, the patient, and the injury.

3.

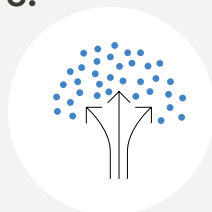

Preservation of the blood supply to soft tissues and bone by gentle reduction techniques and careful handling.

4.



Early and safe mobilization and rehabilitation of the injured part and the patient as a whole.

1. Müller ME, Allgöwer M, Schneider R, Willenegger H. Manual of Internal Fixation. 3rd ed. Berlin, Heidelberg New York: Springer 1991.

2. Buckley RE, Maran CG, Apivatthakakul T. Principles of Fracture management 3rd ed. Vol 1st Principles, Vol. 2: Specific fractures. Thieme; 2017.

Indications

The RFN-Advanced Retrograde Femoral Nailing System (RFNA) is intended to stabilize fractures of the distal femur and the femoral shaft, including:

- Supracondylar fractures, including those with intra-articular extension
- Combination of ipsilateral condylar and diaphyseal fractures
- Ipsilateral femur/tibia fractures
- Femoral fractures in multiple trauma patients
- Periprosthetic Fractures
- Fractures in the morbidly obese
- Fractures in osteoporotic bone
- Impending pathologic fractures
- Malunions and nonunions

▲ WARNINGS

- It is critical to ensure proper selection of the implant meets the needs of the patient anatomy and the presenting trauma
- Use of these devices is not recommended when there is systemic infection, infection localized to the site of the proposed implantation or when the patient has demonstrated allergy or foreign body sensitivity to any of the implant materials.
- Physician should consider patient bone quality to ensure it provides adequate fixation to promote healing.
- Conditions that place excessive stresses on bone and implant such as severe obesity or degenerative diseases, should be considered. The decision whether to use these devices in patients with such conditions must be made by the physician taking into account the risks versus the benefits to the patients.
- Compromised vascularity in the site of proposed implantation may prevent adequate healing and thus preclude the use of this or an orthopaedic implant.

Opening the Distal Femur

1. Position Patient

Position the patient supine on a radiolucent table. The knee of the injured leg should be flexed 30° – 40°. A leg roll may be used to allow proper reduction and stabilization of the fracture.

Position the image intensifier to allow visualization of the proximal and distal femur in AP and lateral views.



2. Reduce fracture

Instruments

394.35* Large Distractor

Perform closed reduction manually by axial traction, under image intensification. If reduction cannot be achieved in a closed approach, open reduction may be considered.

The use of the large distractor may be appropriate in certain circumstances. Consult the corresponding surgical technique.



* Also Available

3. Approach

Make a transligamentous (ligamentum patellae) or a parapatellar incision, depending on the type and location of fracture.

■ **Note:**

If planning the use of the locking attachment washer, a single lateral parapatellar or separate incisions can be made as described in the Locking Attachment Washer technique.

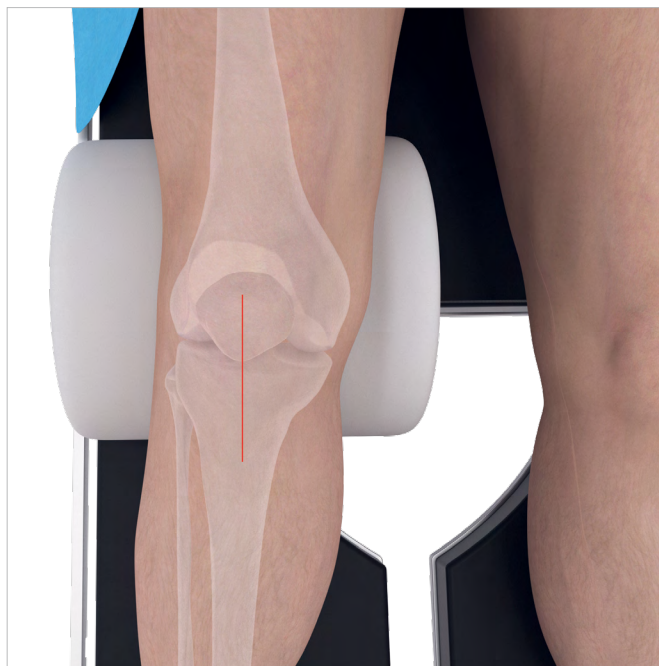

4. Determine entry point

The entry point for the Retrograde Femoral Nail is in line with the medullary canal. The entry point is at the top of the intercondylar notch, just anterior and lateral to the femoral attachment of the posterior cruciate ligament. The entry point determines the anatomic position of the nail in the medullary canal. Special care should be taken to ensure an accurate entry point.

■ **Note:**

In the presence of a femoral prosthesis, the entry point through an open box, may be positioned posteriorly. To accommodate this, a periprosthetic nail is available.



5. Insert guide wire

Instruments

03.010.500	Silicone Handle, with Quick Coupling
03.010.502	13.0 mm Protection Sleeve for RAFN Retrograde, Quick Coupling
03.010.507	Multi Hole Wire Guide for Expert Retrograde Femoral Nail
03.045.018	Guide Wire with Drill Tip, Ø 3.2 mm, 400 mm

Alternative Instruments

357.399	Ø 3.2 mm Guide Wire, 400 mm
---------	-----------------------------

Assemble the handle, protection sleeve and multi hole wire guide. Insert the assembly through the incision to the bone. Hold the protection sleeve firmly and insert the guide wire through the wire guide.

■ Note:

The nail has a distal bend and a radius of curvature to match an average femur. The nail design should be considered relative to the anatomy of the femur when choosing the guide wire starting point and entry angle to ensure proper placement.

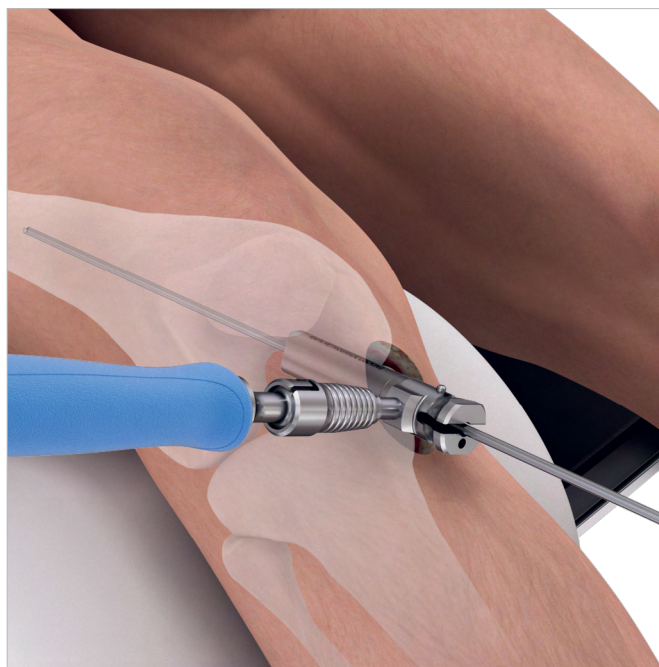

Verify guide wire position under image intensification with AP and lateral views. Remove the wire guide.

▲ **Precaution:**

To reduce the risk of malreduction during nail insertion in patients with good bone quality:

- Consider achieving and maintaining fracture reduction first.
- Consider directing guide wire anteriorly based on nail design and fracture pattern.

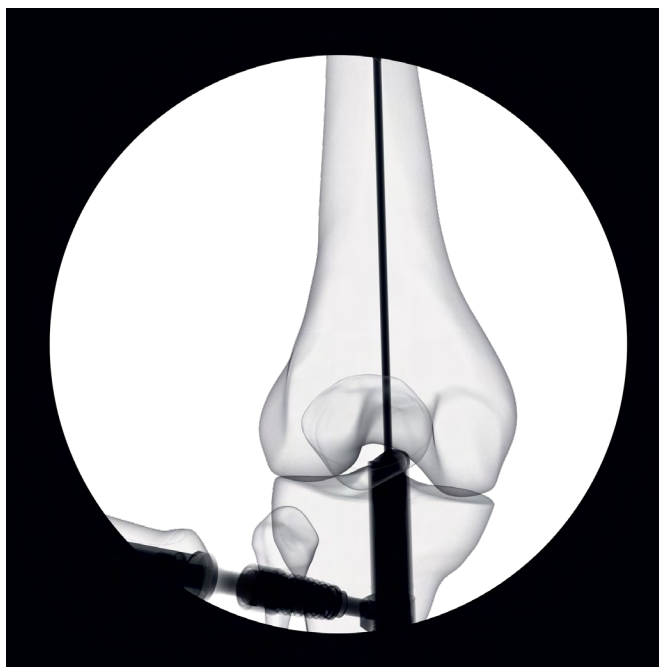
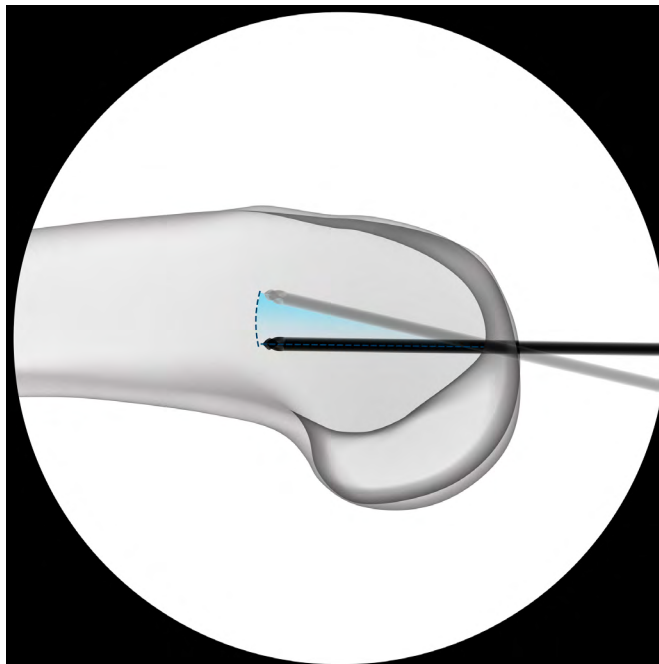

5. OPTION: Insert guide wire in presence of TKA

Instruments

03.010.500	Silicone Handle, with Quick Coupling
03.010.502	13.0 mm Protection Sleeve for RAFN Retrograde, Quick Coupling
03.233.000	Periprosthetic Wire Guide
03.045.018	Guide Wire with Drill Tip, Ø 3.2 mm, 400 mm

Alternative Instruments

357.399	Ø 3.2 mm Guide Wire, 400 mm
---------	-----------------------------

In the presence of a periprosthetic fracture, the dedicated periprosthetic wire guide can be used to assist in determination of nail fit through the open box prosthesis.

The distal end of the periprosthetic wire guide matches the dimensions of the distal end of the nail. Insert the distal end of the periprosthetic wire guide into the open box to confirm fit.

Assemble the handle, protection sleeve and periprosthetic wire guide. Insert the assembly through the incision to the bone. Hold the protection sleeve firmly and insert the guide wire through the wire guide.

■ Note:

In the presence of a femoral prosthesis, the entry point through an open box may be positioned posteriorly. To accommodate this, a periprosthetic nail is available. Consider the start point and trajectory of the guide wire when selecting the appropriate nail.

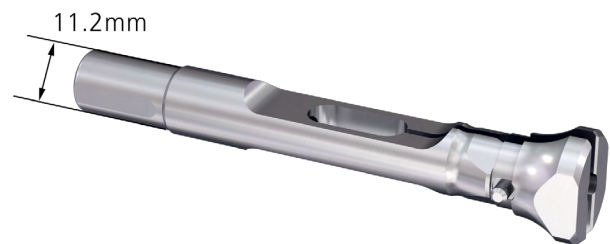
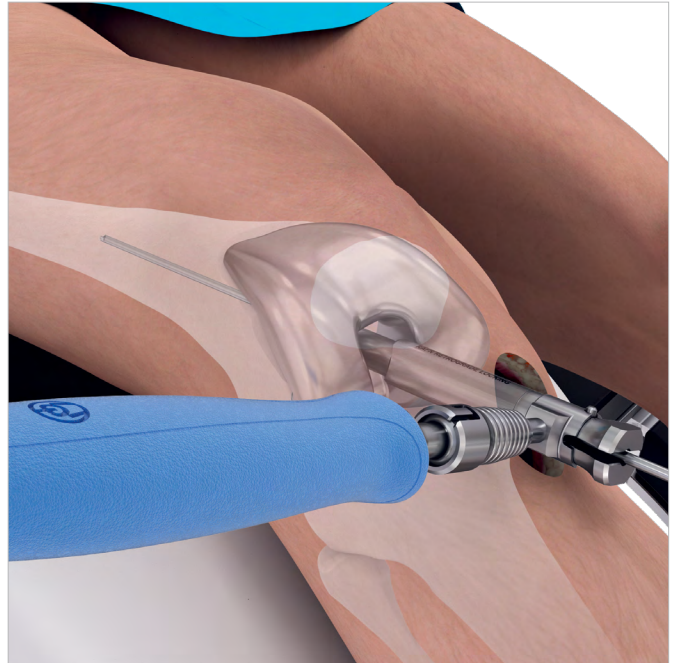

6. Open medullary canal

Instruments

03.233.001 Drill Bit, Cannulated, Ø 12.8 mm,
Large Quick Coupling

Using the protection sleeve and cannulated drill bit, drill over the 3.2 mm guide wire until the drill stop on the drill reaches the protection sleeve.

Monitor progress of the drill with the image intensifier. Ensure that the lateral and medial cortical walls are not compromised. Adjust the guide wire if necessary.

Remove the guide wire, protection sleeve, and drill bit.

▲ Precaution:

For the larger, 14 mm nails, in addition to the 12.8 mm drill bit, the use of the medullary reaming system is needed to open the femur. In this case use the 12.8 mm drill bit for initial opening and continue using the medullary reaming system. Consult the corresponding surgical technique.

■ Note:

Dispose of the guide wire, do not reuse.

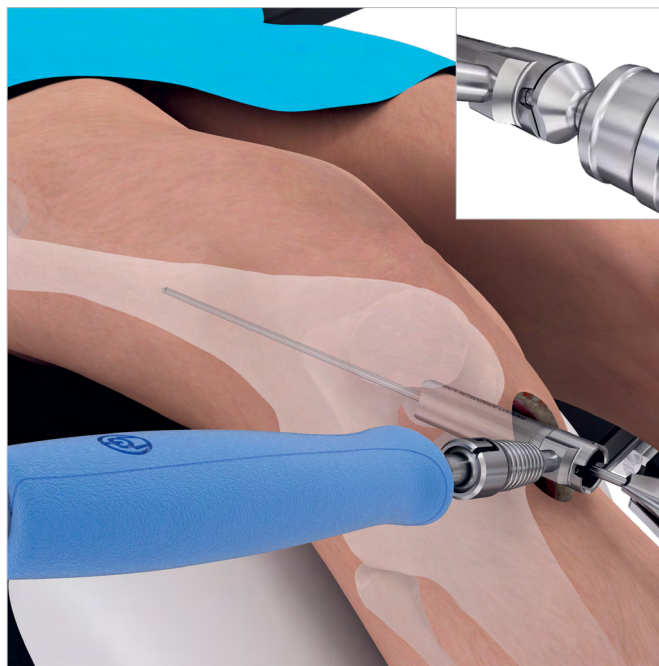

6. Option: Open medullary canal in presence of TKA

Instruments

03.233.002 Drill Bit, Cannulated, Ø 11.2 mm, Large Quick Coupling

Using the protection sleeve and cannulated drill bit, drill over the 3.2 mm guide wire until the drill stop on the drill reaches the protection sleeve.

Monitor progress of the drill with the image intensifier. Ensure that the lateral and medial cortical walls are not compromised. Adjust the guide wire if necessary.

Remove the guide wire, protection sleeve, and drill bit.

Note:

Ensure care is taken not to dislodge the femoral components of any prosthesis and that any components are compatible with selected implants.

Notes:

- When the femoral component has a narrow intercondylar box, the 11.2 mm drill bit can be used with nails 9–12 mm diameter.
- The medullary reaming system can be used to enlarge the opening when needed, based on the size of femoral component intercondylar box. Consult the corresponding surgical technique.
- Dispose of the guide wire. Do not reuse.

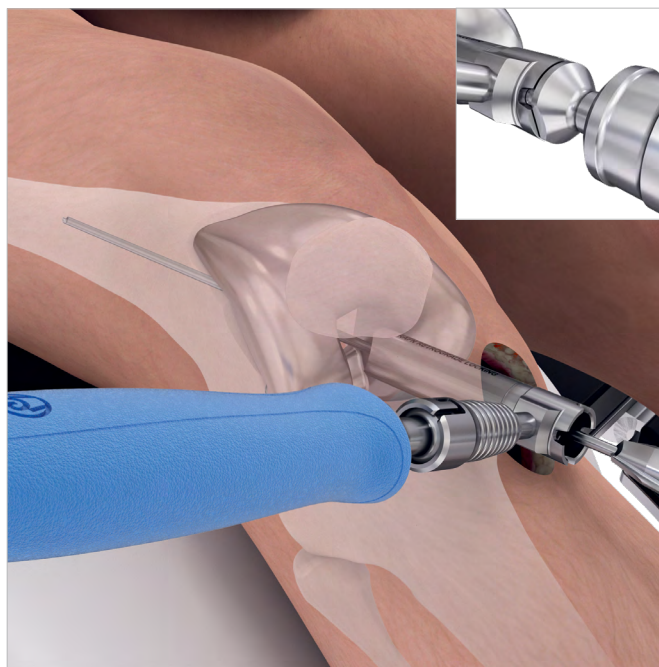
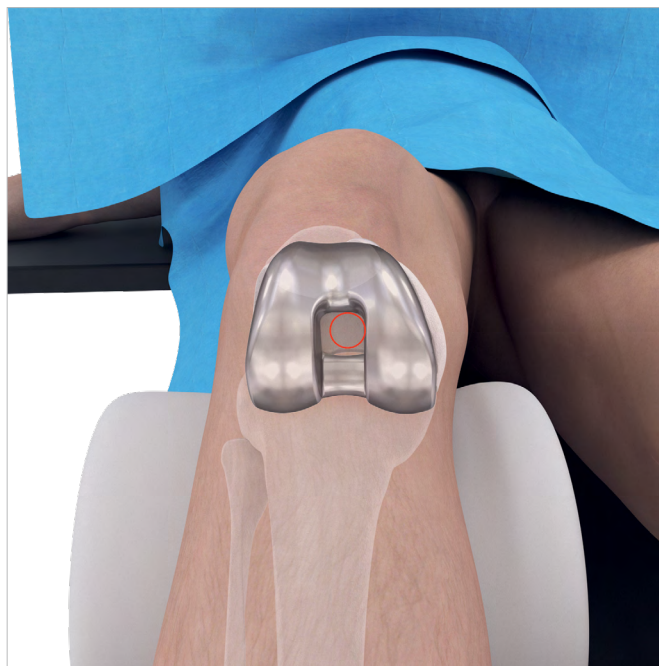

Option: Reduce fracture

Instruments

351.706S	2.5 mm Reaming Rod with Ball Tip, 950 mm, Sterile
351.707S	2.5 mm Reaming Rod with Ball Tip & extension 950 mm, Sterile
351.708S	2.5 mm, Reaming Rod with Ball Tip, 1150 mm, Sterile
03.233.010S	Reaming Rod Ø 3.8 mm, Ball Tip, Ø 3.0 mm, 950 mm, Sterile
03.233.011S	Reaming Rod Ø 3.8 mm Ball Tip, Ø 3.0 mm, 1150 mm, Sterile
03.010.495	IMN Reduction Tool, curved with Quick Coupling
03.010.496	T-Handle cannulated with Quick Coupling
03.010.093	Reaming Rod Push Rod with Ball Handle

The use of a reaming rod can facilitate reduction, serve as a guide for intramedullary reamers, and aid in keeping bone fragments aligned during nail insertion.

The Retrograde Femoral Nail Advanced is cannulated and can be inserted over reaming rods with a maximum diameter of 3.85 mm at the widest point, typically at the ball tip.

The use of the reduction finger may be appropriate in certain circumstances to help achieve alignment of the proximal and distal fragments and guide the reaming rod to the proximal fragment.

Insert the reduction instrument to the desired depth. Pass the reaming rod through the cannulation of the instrument.

Remove the reduction instrument.

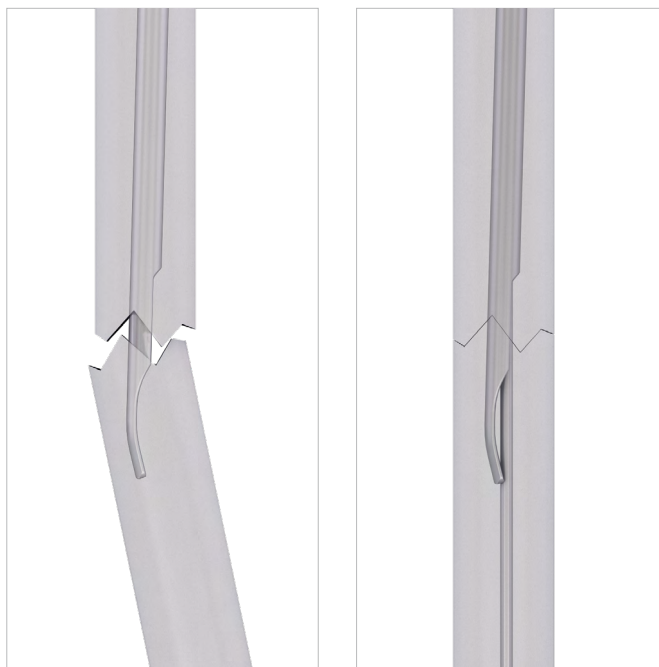

Note:

Use the rod pusher to help retain the reaming rod during the extraction of the reduction instrument.

Option: Determine nail length over reaming rod

Instruments

351.717	Depth Gauge
351.719	Depth Gauge Extension Tube

Nail length can be determined over a 950 mm reaming rod. Confirm reaming rod insertion depth under image intensification and account for a possible distraction at the fracture site.

Assemble the depth gauge and tube and pass the assembly over the reaming rod and down to the nail entry point. Read nail length directly from the measuring device.

■ Notes:

- If a 1150 mm reaming rod is used, the nail length measurement should be read off the etched line on the reaming rod.
- The nail diameter is determined either by reaming (optional) or radiographically.



Reaming (optional)

Ream medullary canal (optional)

Instruments

03.010.093	Reaming Rod Push Rod with Ball Handle
351.706S	2.5 mm Reaming Rod with Ball Tip, 950 mm, Sterile
351.707S	2.5 mm, Reaming Rod with Ball Tip & Extension, 950 mm, Sterile
351.708S	2.5 mm Reaming Rod with Ball Tip, 1150 mm, Sterile
03.233.010S	Reaming Rod Ø 3.8 mm Ball Tip, Ø 3 mm, 950 mm, Sterile
03.233.011S	Reaming Rod Ø 3.8 mm Ball Tip, Ø 3 mm, 1150 mm, Sterile
03.043.001	Universal Chuck

If necessary, enlarge the femoral canal with the medullary reamer to the desired diameter using a DePuy Synthes reamer system intended for femoral reaming procedures by following the corresponding instructions for the reamer system.

Use image intensification to confirm fracture reduction. Insert the reaming rod into the medullary canal to the desired insertion depth. The tip must be correctly positioned in the medullary canal since it determines the final position of the nail. Use image intensification in AP and lateral view to ensure that the reaming rod is placed in a central position.

▲ Precaution:

The Retrograde Femoral Nail Advanced is cannulated and can be inserted over reaming rods with a diameter up to 3.85 mm at the widest point. Compatible reaming rods will pass through the hole in the center of the aiming arm.

■ Note:

Use the rod pusher to help retain the reaming rod during reamer extraction.

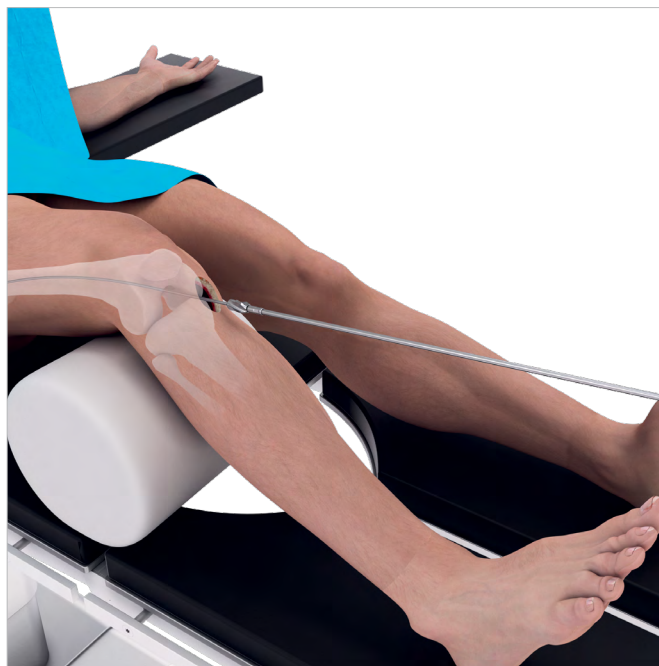

Insert Nail

1. Assemble insertion instruments

Instruments

03.233.005	Insertion Handle
03.233.003	Connecting Screw
03.233.004	Nail Assembly Instrument
03.037.031	Combination Wrench

Thread nail assembly instrument into connecting screw until secure. Fully insert assembly into insertion handle by turning assembly until secure.

Align the tip of the nail assembly instrument that protrudes through the insertion handle into the center of the nail and insert, matching the geometry of the insertion handle with the notches in the nail.

Note: the insertion handle will be positioned anteriorly during nail insertion.

Turn the connecting screw to secure it to the nail. Confirm the connecting screw is securely tightened to the nail with the combination wrench. Do not over-tighten.

Remove the nail assembly instrument.

Precaution: Ensure the connection between the nail and the insertion handle is tight. Retighten if necessary.

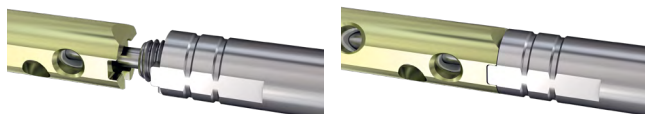
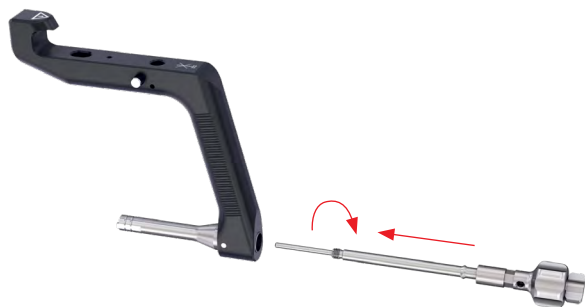
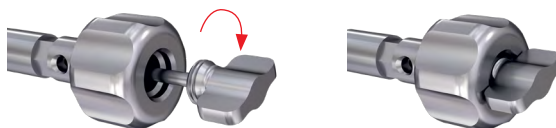
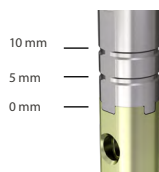

2. Insert Nail

Optional Instruments

03.010.522	Spiral Combination Hammer, 500 grams
03.010.170	Hammer Guide

With the insertion handle positioned anteriorly, insert the nail using the insertion handle over the reaming rod if used, into the medullary canal as far as possible by hand.

Monitor nail passage across the fracture. Control in two planes to avoid malalignment.

Insert the nail to the desired depth. Insertion depth is indicated by the grooves on the insertion handle. The notch indicates the end of the nail. The subsequent distances between the grooves on the insertion handle represent 5 mm and correspond to the extensions of the end caps.

Insertion depth can be verified with a lateral image. Use Blumensaats line as a reference. Check the final position of the nail in the AP and lateral views.



Insert Nail

If necessary, insert the nail with light hammer blows. Monitor the tip of the nail using image intensification. If the nail has been slightly over-inserted, the hammer guide can be used to back slap the nail. Attach the hammer guide to the connecting screw. Use light hammer blows along the hammer guide to back slap the nail.

▲ Precaution:

Do not strike the insertion handle directly, to avoid damage to the handle.

■ Note:

After using the hammer, ensure the connecting screw is securely tightened to the nail. Retighten, if necessary.

Remove the reaming rod, if used.



Fixation Options



Standard Locking, Page 23



Locking Attachment Washer, Page 36



Condylar Nut and Washer, Page 50

Locking Screw Options

About Measuring Screw Length

Screw length is measured by using either of two methods.

1. Read length from the calibrated drill bits
2. Measure length using depth gauge for locking screws

Readings do not reflect the measured distance, they indicate the required screw length. The reading on the scale will correspond to the screw length as indicated on the screw label, taking into account the amount of screw tip protrusion required to get full screw thread engagement in the far cortex.

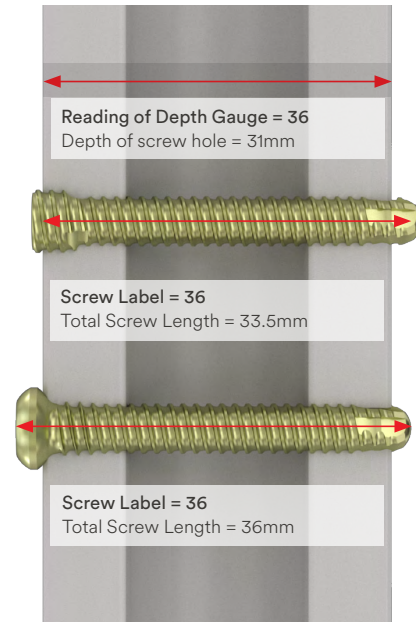

■ Notes:

- Drill bit location with respect to the far cortex is critical for measuring the appropriate locking screw length.
- Beware depth gauges are implant specific. Always use the appropriate depth gauge as specified in surgical technique guide.

▲ Precaution:

Select adequate screw lengths to avoid protrusion of the screw tips and irritation of soft tissue.

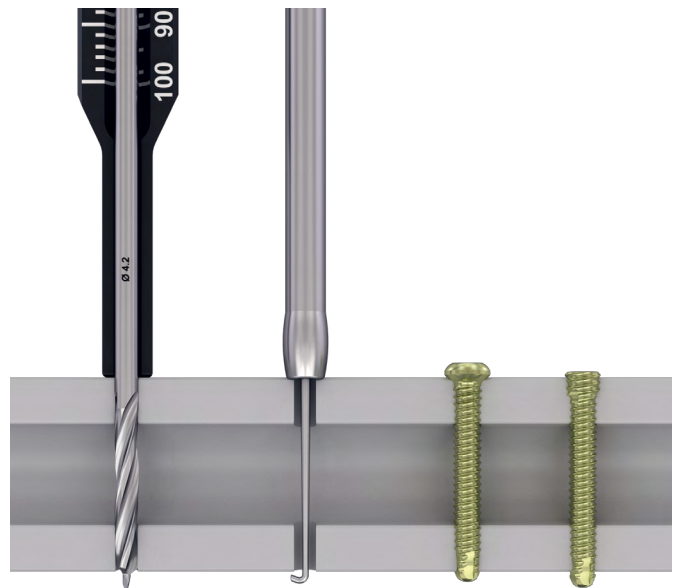

Retrograde Femoral Nail Advanced System offers two types of screws:

1. Locking Screw
Standard IM nail locking screw
2. Low Profile Locking Screw
The low profile screw has been designed to reduce implant prominence in places with minimal soft tissue coverage.

1 Locking Screw 2 Low Profile Locking Screw

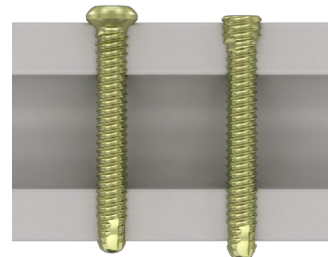

Both types of screws have a threaded recess and can be securely attached to the screwdriver by using the retention pins. To do so, slide the retention pins through the back of the screwdriver until it stops. Further advance it by turning it clockwise, until its tip extends out of the tip of the screwdriver.

Engage the screwdriver in the recess of the locking screw and thread the retention pin into the screw's recess to lock the screw to the screwdriver.

Alternatively, the screw can be partially inserted with a power tool, by using the screwdriver shaft with its retention pin, following the same steps as described above.

Retention Pin

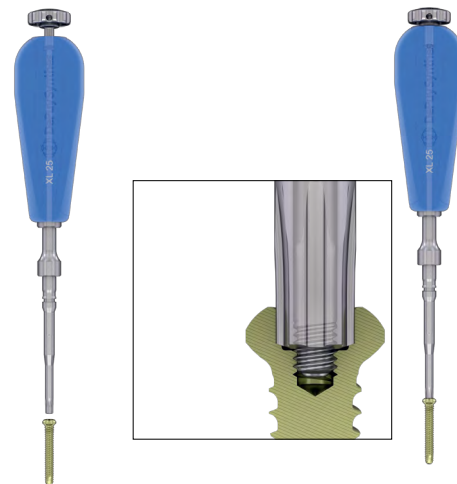

▲ Precaution:

The screw must not be tightened with the power tool. Disengage the power tool from the screwdriver shaft before the screw is fully seated and use the manual handle to bring the screw to its final position and tighten it as appropriate.

■ Note:

Both types of screws have a threaded recess and can be securely attached to the screwdriver by using the retention pins (1.). To do so, slide the retention pin through the back of the screwdriver until it stops (2.). Further advance it by pushing it through, until it clicks into place and its tip extends out of the tip of the screwdriver (3.).

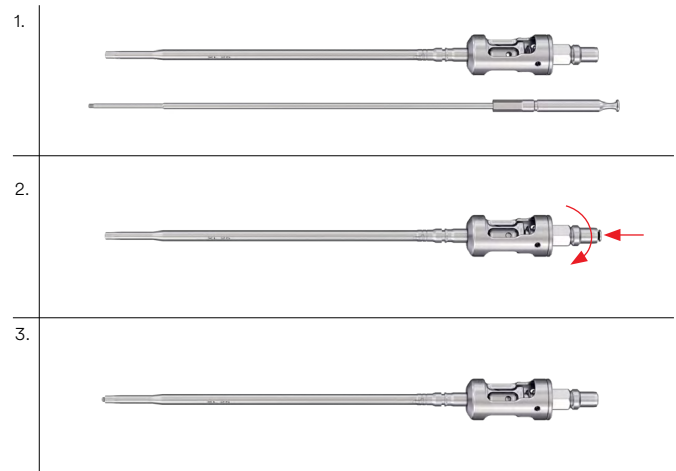

Low Profile Screw

The Low Profile Locking Screw can be used instead of the standard locking screw, by following the same basic steps for screw insertion.

An optional sleeve is available to indicate when the screw is fully seated. Slide it over the tip of the screwdriver until it locks in place.

In its initial position, it will cover the head of the screw, protecting surrounding soft tissues from the screw head's cutting flutes. Advance the screw until the sleeve touches the cortex.

Note:

Pay attention not to damage the cortex with the sleeve.

Then retract the sleeve by pushing the release button and pulling it backwards towards the screwdriver handle.

Continue to advance the screw, now sinking the screw head into the bony cortex. Once the sleeve touches the cortex a second time, the screw head will be 0.5 mm proud of the cortex.

The cutting flutes in the 5 mm low profile screw's head are designed to allow insertion of the screw without any extra steps. However, in hard bone it is recommended to enlarge the near cortex with the \varnothing 5.5 mm reamer, to make room for the screw head, and avoid excessive insertion torque.

Low Profile Locking Screw

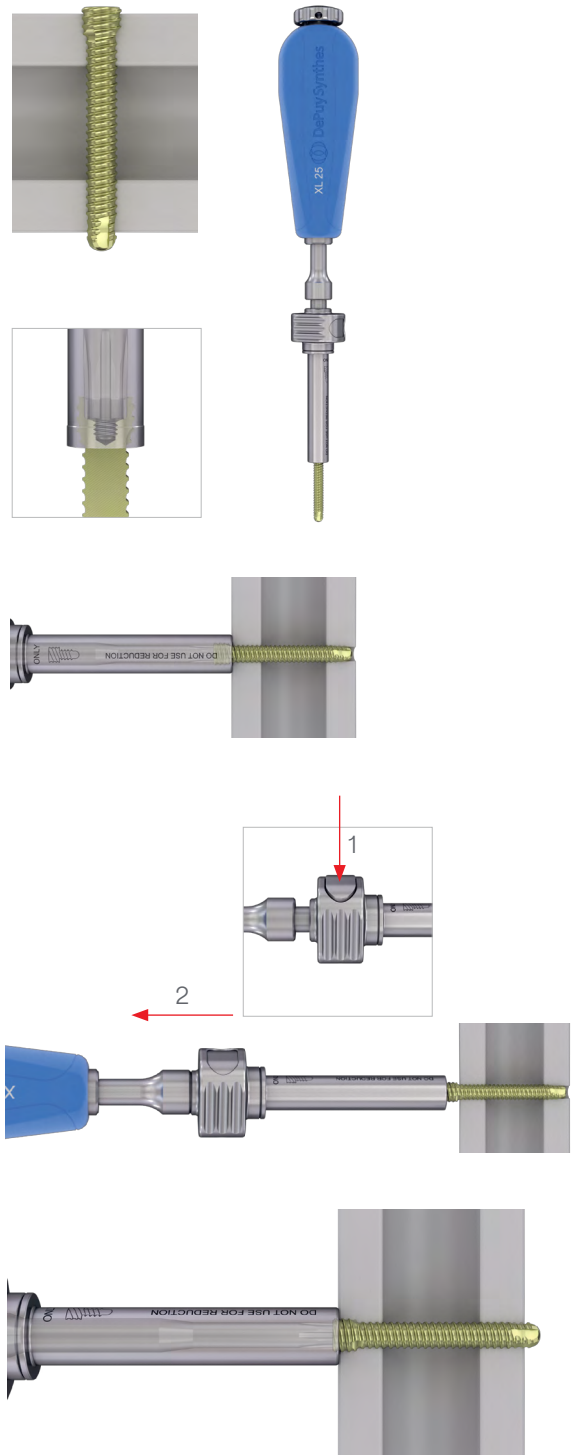

Locking

1. Connect the aiming arm

Instruments

03.233.006 Aiming Arm, Radiolucent

Attach the aiming arm to the insertion handle, by sliding the aiming arm into the hook end of the insertion handle (1) and then rotating the aiming arm towards the insertion handle, such that the latch on the aiming arm connects to the insertion handle (2).

▲ Caution:

Do not exert force on the aiming arm, protection sleeve, drill sleeves and drill bits. These forces may prevent accurate targeting through the locking holes and damage the drill bits.



2. Insert trocar combination

Instruments

03.045.019	Protection Sleeve, Ø 11/8
03.045.020	Drill Sleeve, Ø 4.2 mm
03.010.070	4.2 mm Trocar 210 mm

Insert the three-part trocar assembly (protection sleeve, drill sleeve and trocar) through the desired hole in the aiming arm and rotate the protection sleeve to align the arrow on the protection sleeve with the arrow on the aiming arm. Make a stab incision and insert the trocar to the bone. Twist the protection sleeve by a quarter turn to lock it into place. Remove the trocar.

▲ Caution:

Avoid putting tension on the aiming arm and insertion handle, when locking the protection sleeves, as this can reduce the accuracy of the aiming arm. The sleeves need to contact the cortex, but tension can occur if the protection sleeves are pushed down too hard.

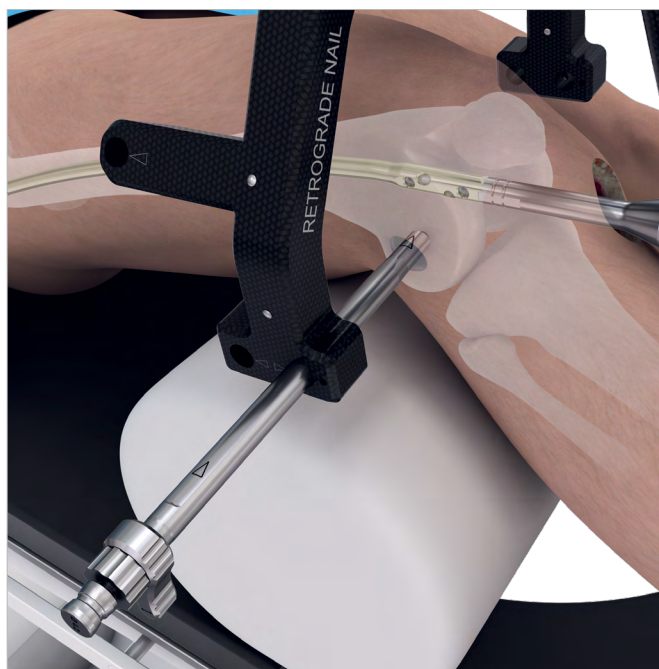
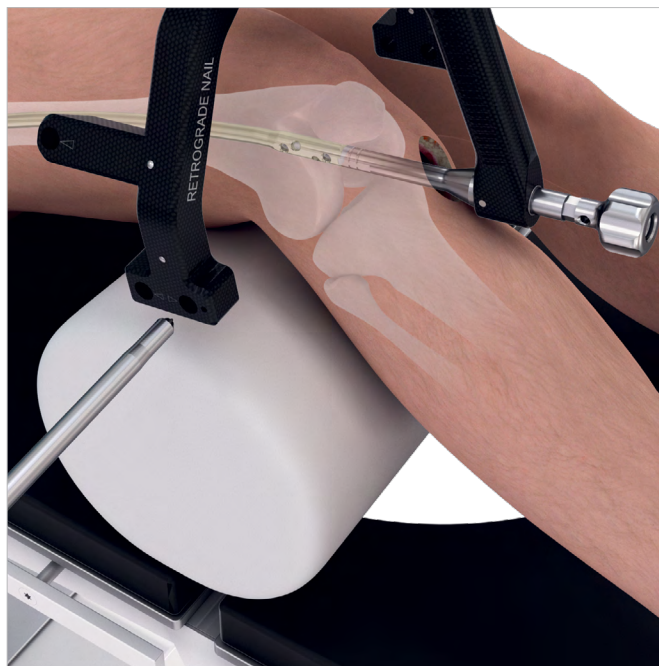

3. Drill and determine locking screw length

Instrument

03.045.022 Drill Bit, Calibrated, Ø 4.2 mm, Extra-Long

Ensure that the drill sleeve is pressed firmly to the near cortex. Using the drill bit, drill to the desired depth and confirm drill bit position after drilling.

Ensure that the drill sleeve is pressed firmly to the near cortex and read the measurement from the drill bit at the back of the drill sleeve. This measurement corresponds to the appropriate length locking screw.

Remove the drill bit and the drill sleeve.

Alternative Instrument

03.019.017 Depth Gauge for Multiloc Humeral Nailing System

After drilling, remove the drill bit and the drill sleeve.

Insert the depth gauge through the protection sleeve. Confirm the position of the depth gauge hook and that the depth gauge sleeve is firmly pressed against the near cortex.

Read the measurement from the depth gauge to determine the appropriate length locking screw.

■ Note:

For screw lengths longer than 100 mm, the 03.045.022 drill bit should be used to confirm screw length.



4. Insert locking screw

Instruments

03.045.001 Screwdriver XL25

03.045.002 Retention Pin for Screwdriver XL25

Use the screwdriver to insert the appropriate length locking screw through the protection sleeve.

Repeat Steps 2 and 3 for additional distal locking screws.

Turn the retention pin counterclockwise to disengage the retention pin from screw head. Remove screwdriver, protection sleeve and the aiming arm.

Note:

In a Standard Locking construct, the use of a 0 mm end cap may reduce the risk of screw migration (refer to Step 5).



Standard Locking Construct

Alternative Instruments

03.045.005	Screwdriver XL25 Quick Coupling Hex 12 mm
03.045.006	Retention Pin for Screwdriver, with Quick Coupling-Hex 12 mm, XL25
03.140.027	Large Cannulated Handle with Quick Coupling, 12 mm Hex

Use the screwdriver attached to power to insert the appropriate length locking screw through the protection sleeve, until the head of the locking screw is close to contacting the near cortex.

Note:

Final tightening of locking screws must be completed with manual detachable handle. Disengage the power tool from the screwdriver shaft before the screw is fully seated and use the handle to bring the screw to its final position.

The shaft of the screwdriver has two lines, one of which indicates insertion depth of the standard locking screw (1), and the other indicating insertion depth of the Low Profile locking screw (2) relative to the tip of the protection sleeve.

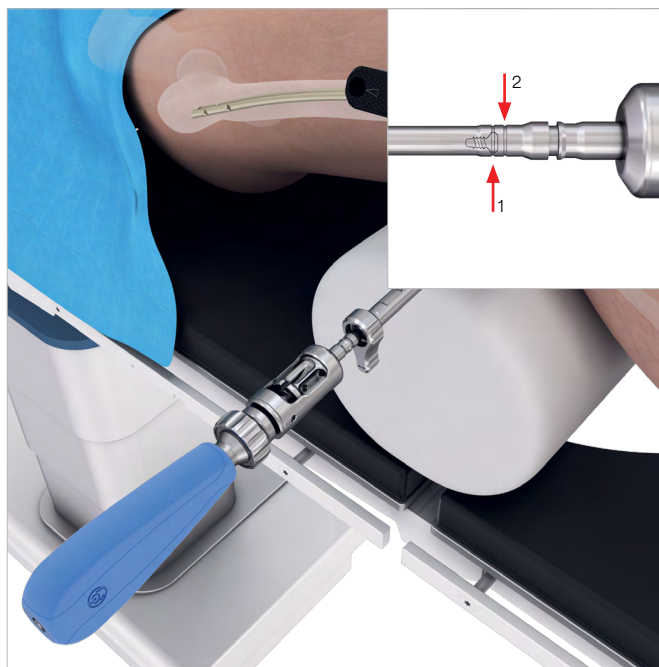

Option: Low profile locking screw

Instruments

03.045.009 Sleeve for Screwdriver

03.045.029 Reamer Ø 5.5 mm

The low profile screw can be used instead of the standard locking screw, by following the same basic steps for screw insertion.

An optional sleeve is available to indicate when the screw is fully seated. Slide it over the tip of the Screwdriver until it locks in place.

Before using the sleeve, unlock the protection sleeve, ensure it contacts the bone, and lock it into place again by twisting it a quarter turn.

The use of a Ø 5.5 mm reamer, to make room for the screw head, is recommended in hard bone.



5. Option: Insert 0 mm End Cap

Instruments

03.045.005	Screwdriver XL25 Quick Coupling Hex 12 mm
03.045.006	Retention Pin for Screwdriver, with Quick Coupling-Hex 12 mm, XL25
03.010.496	T-Handle, cannulated, with Quick Coupling

Remove the connecting screw.

For the 0mm end cap, the insertion handle can remain in place to help align the end cap to the nail. The end cap fits through the barrel of the insertion handle.

Insert end cap through barrel of insertion handle and tighten until secure. Thread the end cap into the nail until it engages the most distal screw. To achieve higher insertion torque, use the T-Handle to ensure the end cap is tight to the distal screw. Image intensification may be used to visualize the end cap contacting the screw.

If desired, the end cap can be locked to the screwdriver by use of the retention pin.

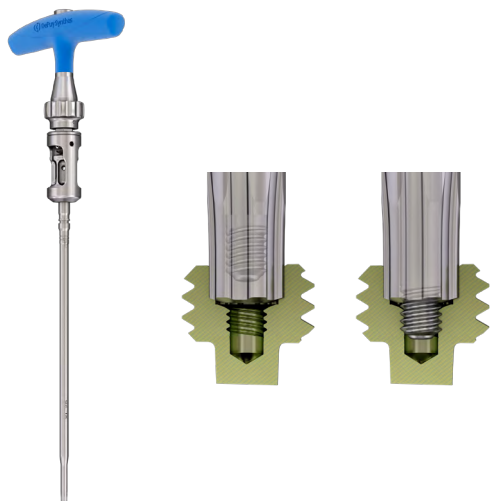

Freehand Locking

1. Align image intensifier

Confirm reduction and correct alignment with AP and lateral images.

Align the image intensifier with the hole in the nail closest to the fracture until a perfect circle is visible in the center of the screen.



2. Determine incision point

Place a scalpel blade or the tip of a drill bit on the skin over the center of the hole to mark the incision point and make a stab incision.



3. Drill

Instruments

03.010.104	4.2 mm, three-fluted Drill Bit Quick Coupling, Needle Point, 145 mm
------------	---

Insert the drill bit through the incision, down to the bone.

Incline the drive so that the tip of the drill bit is centered over the locking hole. The drill bit should almost completely fill the circle of the locking hole. Hold the drill bit in this position and drill through both cortices.

■ Note:

For greater drill bit control, discontinue drill power after perforating the near cortex. Manually guide the drill bit through the nail before resuming power to drill the far cortex.



4. Determine length of locking screw

Instruments

03.010.104 4.2 mm, three-fluted Drill Bit, Quick Coupling, Needle Point, 145 mm

03.010.429 Direct Measuring Device for Locking Screws to 100 mm for IM Nails

Stop drilling immediately after penetrating the far cortex. Disassemble the drill bit from the power equipment.

Under image intensification, ensure the correct position of the drill bit relative to the far cortex. Place the direct measuring device onto the drill bit. Read the screw length directly from the measuring device at the end of the drill bit. This corresponds to the appropriate locking screw length.

■ Note:

Correct placement of the drill bit and measuring device are important for accurate locking screw length measurement.



Alternative Instruments

03.019.017 Depth Gauge for Multiloc Humeral Nailing System

Measure the locking screw length using the depth gauge. Ensure the outer sleeve is in contact with the bone and the hook grasps the far cortex.

Read the locking screw length directly from the depth gauge at the back of the outer sleeve.



5. Insert locking screw

Instruments

03.045.003	Screwdriver Short XL25
03.045.004	Retention Pin for Screwdriver, Short, XL25

Use the screwdriver to insert the appropriate length locking screw.

Verify locking screw length under image intensification. If needed, a second locking screw may be inserted using the same technique.

Repeat Steps 1 through 5 for the second proximal locking screw.



Alternative Instruments

-
- | | |
|------------|--|
| 03.045.007 | Screwdriver Short, XL25, Quick Coupling, Hex 12 mm |
| 03.045.008 | Retention Pin for Screwdriver with Quick Coupling-Hex 12 mm, Short, XL25 |
| 03.140.027 | Large Cannulated Handle with Quick Coupling-12 mm Hex |
-

Use the screwdriver attached to power to insert the appropriate length locking screw, until the head of the locking screw is close to contacting the near cortex. Remove the screwdriver from the power coupling, and attach to the handle to complete insertion manually.

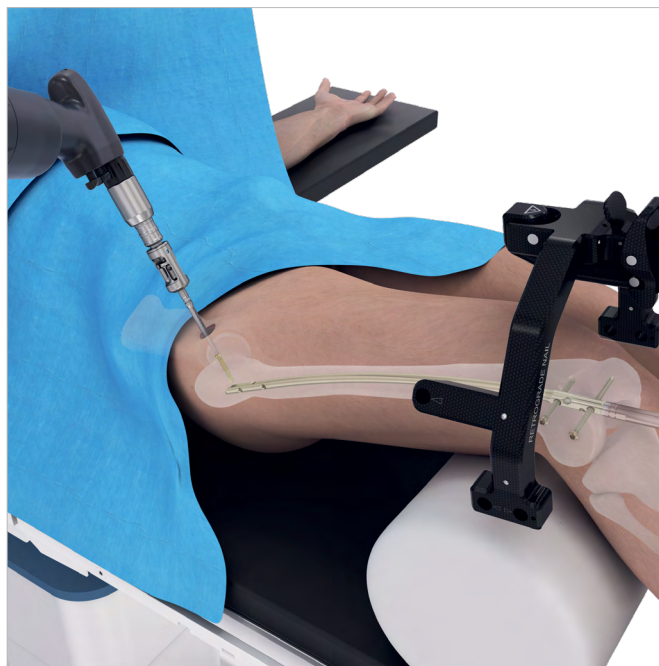

LAW Technique – Locking Attachment Washer



Locking Attachment Washer

Locking Attachment Washer for RFN-Advanced

The Locking Attachment Washer is pre-contoured and is offered in a 5° and a 10° version to account for screw hole position relative to the position of the nail in the bone.

The Left and Right versions of each are shown below.

Note:

The position of the posterior 3.5 mm VA Locking Screws is different between left and right locking attachment washers. This difference accounts for the position of the descending oblique screws when the nail is used in the left or right femur.



Locking Attachment Washer

Locking Attachment Washer for RFN-Advanced

The Locking Attachment Washer contains etch detail to provide information on the locking attachment washer type and orientation.

ANT – indicates the anterior edge
R (or L) – indicates right or left
5° (or 10°) – indicates version

■ **Note:**

there is a line etched between the 5.0 mm VA Locking holes to indicate alignment with the nail.



02.233.100S

Locking Attachment Washer for RFN-Advanced

In certain patients, the 5° Locking Attachment Washer may be suitable for use with a periprosthetic nail, or, the 10° Locking Attachment Washer may be suitable for use with a standard bend nail. The surgeon should consider the position of the nail relative to the pre-contoured fit of the locking attachment washer.

If the position of the proximal lateral-medial screw is superior due to patient anatomy, nail insertion depth, or the presence of a TKA femoral component, the 10° Locking Attachment Washer may have improved fit due to the transition from the epicondyle.



5°
LAW

10° LAW has a larger offset out-of-plane between 5.0 VA Locking holes to account for transition from lateral epicondyle proximally.



10°
LAW

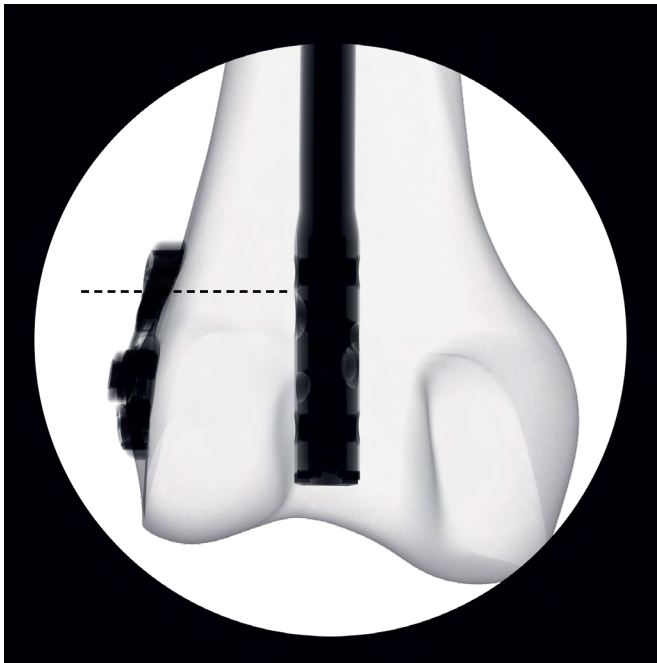

5° Locking Attachment Washer

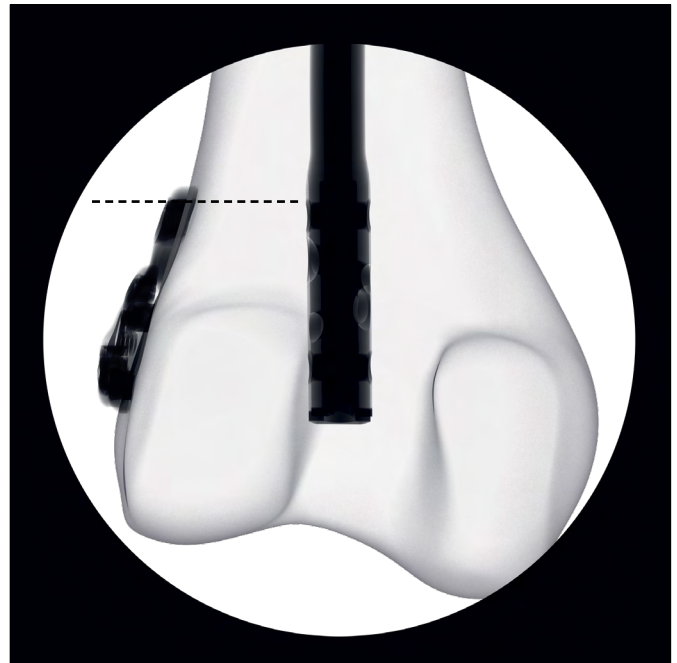

10° Locking Attachment Washer

1. Nail Insertion

Insert the nail using the retrograde technique.

Align the image intensifier to obtain an anatomic lateral view with condylar overlap.

While maintaining this patient position and lateral view, reposition the nail to obtain near perfect circles.

■ Note:

The locking washer is pre-contoured to match the patient anatomy when the nail is positioned as described.

■ Note:

If planning the use of the locking attachment washer in the presence of a TKA femoral component, ensure the footprint of the locking attachment washer will not interfere with or contact the femoral component.



2. Connect the aiming arm

Instruments

03.233.006 Aiming Arm, Radiolucent

Attach the aiming arm to the insertion handle.

▲ Caution:

Do not exert force on the aiming arm, protection sleeve, drill sleeves and drill bits. These forces may prevent accurate targeting through the locking holes and damage the drill bits.



3. Secure Nail in position with a Medial Oblique Screw or Drill Bit

Instruments

03.045.019	Protection Sleeve, Ø 11/8
03.045.020	Drill Sleeve, Ø 4.2 mm
03.010.070	4.2 mm Trocar 210 mm
03.045.022	Drill Bit, Calibrated, Ø 4.2 mm, Extra-Long
03.045.001	Screwdriver XL25
03.045.002	Retention Pin for Screwdriver XL25

Lock the nail to the distal fragment with the medial oblique screw or with a drill bit in the medial oblique hole to limit motion of the nail relative to the distal fragment.

Assemble the three-part trocar combination (protection sleeve, drill sleeve and trocar) and insert it through the medial oblique hole in the aiming arm. Make a stab incision and insert the trocar to the bone. Remove the trocar.

Ensure that the drill sleeve is pressed firmly to the near cortex. Using the drill bit, drill to desired depth.

If using the drill bit to stabilize the nail, decouple the drill bit from the power drill and proceed to Step 4.

If inserting a screw to stabilize the nail, ensure that the drill sleeve is pressed firmly to the near cortex and read the measurement from the drill bit at the back of the drill sleeve. This measurement corresponds to the appropriate length locking screw.

Remove the drill bit and the drill sleeve.

Use the screwdriver to insert the appropriate length locking screw through the protection sleeve, until the head of the locking screw lies against the near cortex.

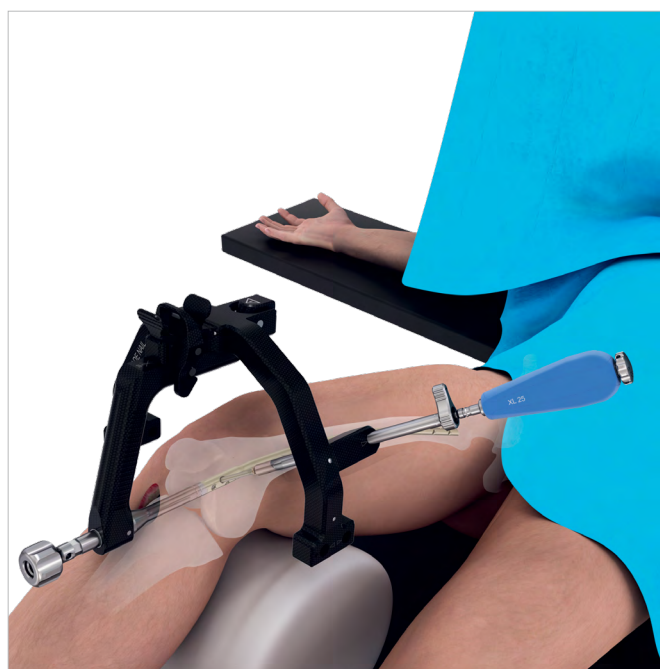
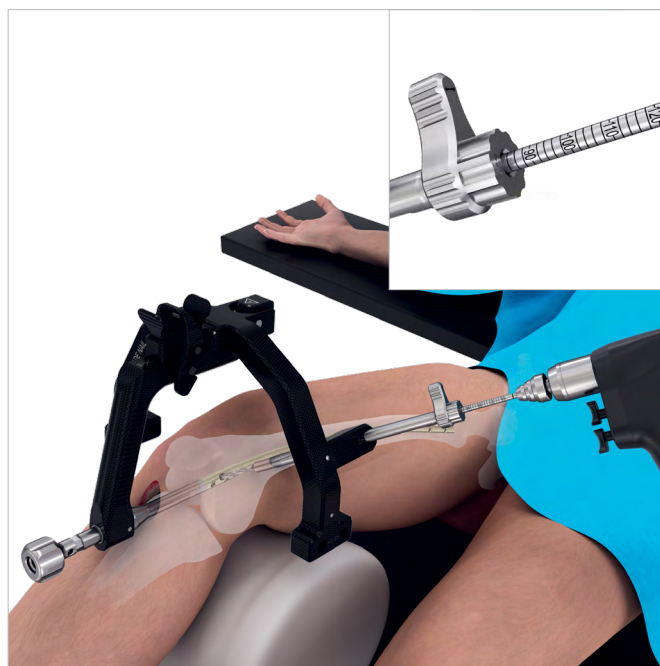

4. Expose Lateral Condyle and Insert Locking Attachment Washer

Instruments

03.233.008	Holding Device Locking Pin, for Locking Attachment Washer
03.233.009	Holding Device Handle, for Locking Attachment Washer
03.045.019	Protection Sleeve, Ø 11/8
03.045.020	Drill Sleeve, Ø 4.2 mm

Create an incision approximately 8 cm in length laterally.

■ Note:

The protection sleeves placed through the aiming arm can be used as an indication of locking attachment washer location.

Assemble a drill sleeve into a protection sleeve. Partially insert a sleeve assembly into each lateral to medial holes in the aiming arm, leaving space to insert the locking attachment washer.

Insert the locking pin into the holding device handle. Attach locking attachment washer to the holding device assembly by aligning the pin and tighten until secure.

Position the Locking Attachment Washer on the bone using the Holding Device such that the two 5.0 VA Locking Holes are aligned with the protection sleeves.

■ Note:

The locking attachment washer is properly positioned when the holding device handle is pointed distally, and oriented anterior to the protection sleeves.

Hold the Locking Attachment Washer in position on the bone using the sleeves.

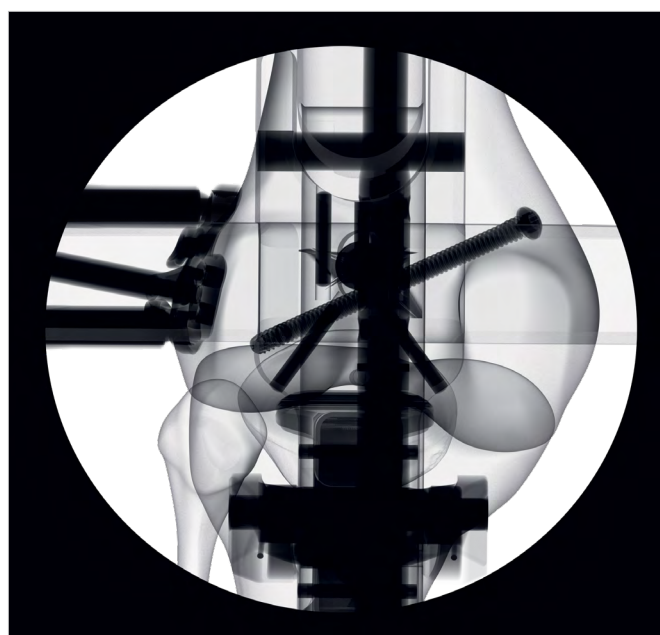
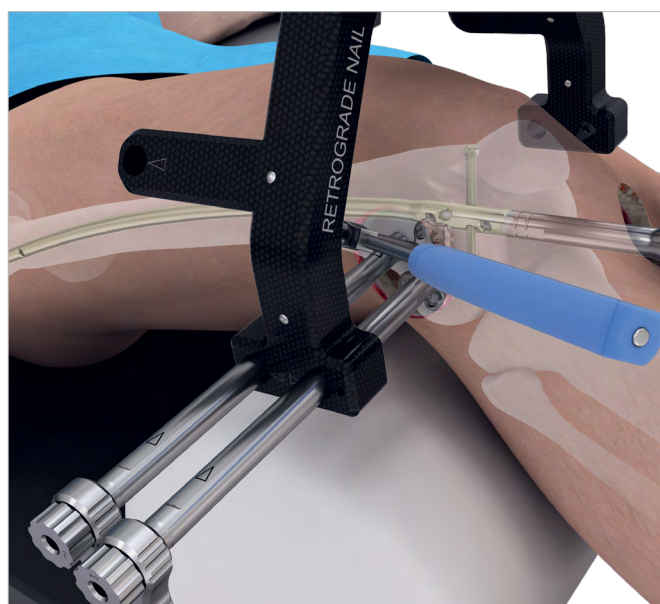
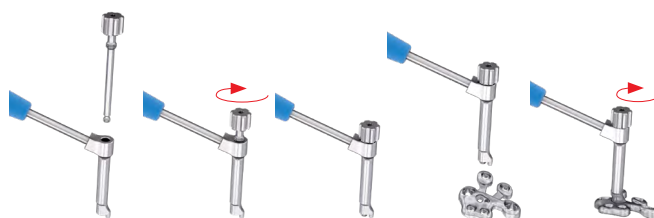

5. Drill 5.0 mm VA Locking Screws

Instruments

03.045.019	Protection Sleeve, Ø 11/8
03.045.020	Drill Sleeve, Ø 4.2 mm
03.045.022	Drill Bit, Calibrated, Ø 4.2 mm Extra-Long

Using the drill bit, drill the proximal hole until the tip of the drill bit penetrates the far cortex.

Leave this drill bit in position by decoupling from the power drill.

Using a second drill bit, drill the distal hole until the tip of the drill bit penetrates the far cortex.
Using drill bit, determine appropriate length 5.0 mm VA locking screw for distal hole.

■ Note:

The 03.019.017 depth gauge can also be used to determine the appropriate length locking screw.

Remove the drill bit and drill sleeve.

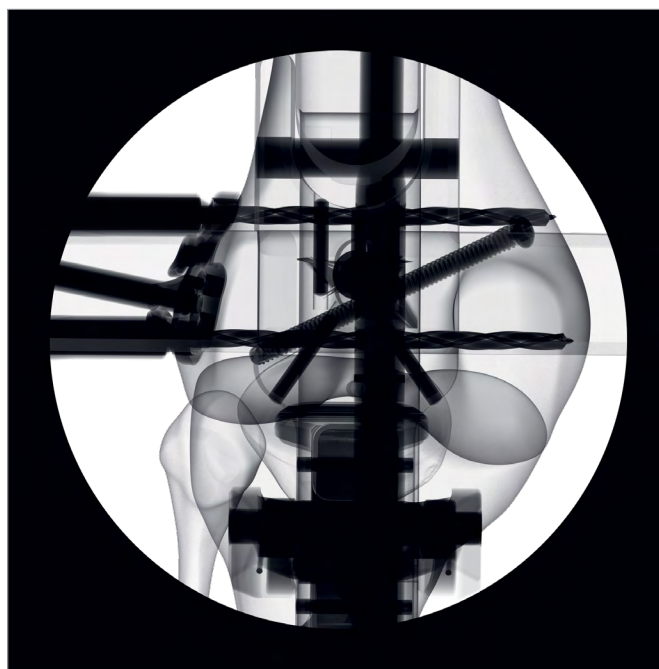
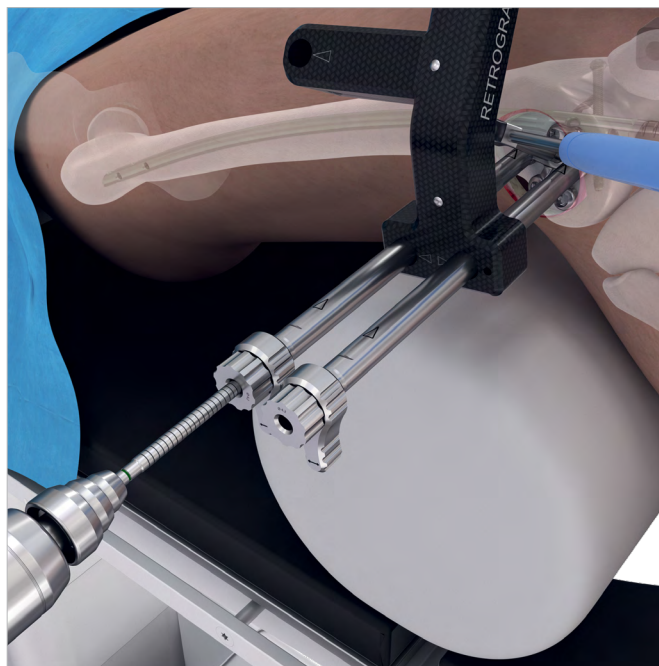

6. Partially Insert 5.0 mm VA Locking Screws

Instruments

03.010.109 T25 Stardrive Screwdriver Shaft

03.045.019 Protection Sleeve, Ø 11/8

Use the screwdriver to insert the appropriate length locking screw through the protection sleeve into the distal hole, stopping approximately 1 cm before full insertion of the screw.

■ Note:

This will allow manipulation of the Locking Attachment Washer to improve the fit on the bone.

The 5.0 mm variable angle locking screws may be inserted using power equipment and the T25 StarDrive screwdriver shaft.

For the proximal screw, determine the screw length using the drill bit. Remove the drill bit and drill sleeve.

Use the screwdriver to insert the appropriate length locking screw through the protection sleeve, stopping approximately 1 cm before full insertion of the screw.

■ Note:

Proceed to the next surgical step with both 5.0 mm VA Locking Screws approximately 1 cm proud of the locking attachment washer.

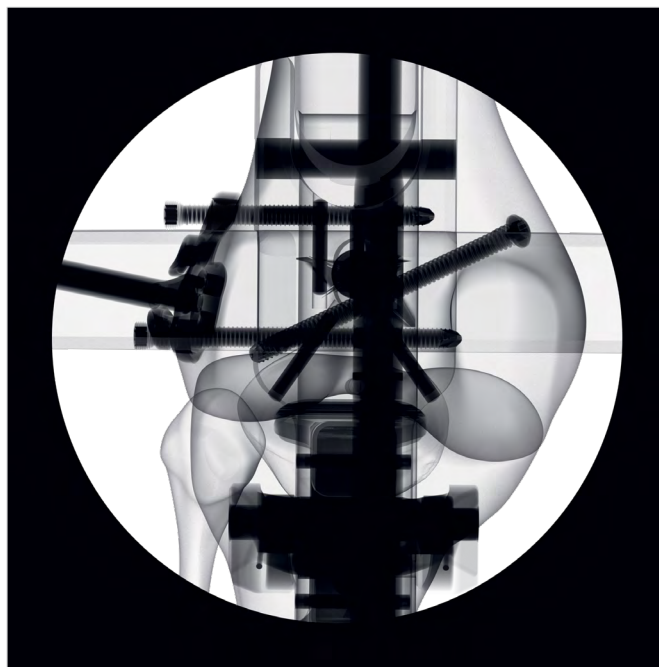
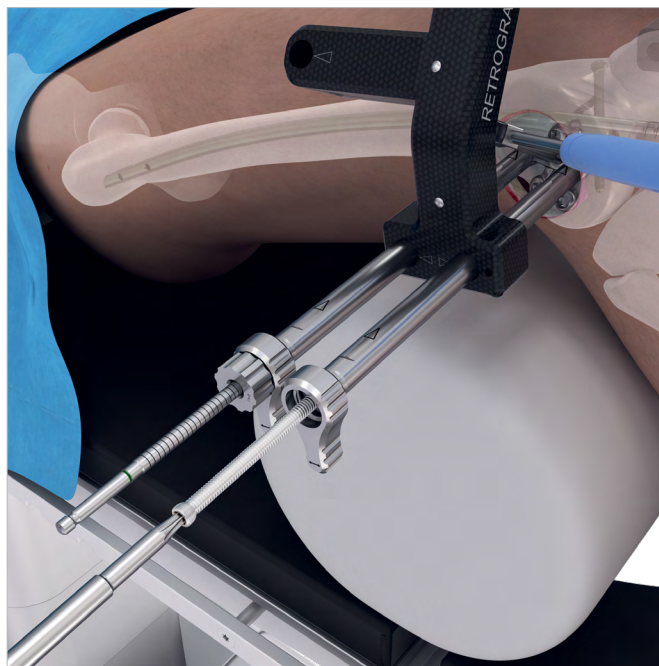

7. Insert Lateral Oblique Screw in Nail (optional)

Instruments

03.045.019	Protection Sleeve, Ø 11/8
03.045.020	Drill Sleeve, Ø 4.2 mm
03.010.070	4.2 mm Trocar 210 mm
03.045.022	Drill Bit, Calibrated, Ø 4.2 mm Extra-Long
03.045.001	Screwdriver XL25
03.045.002	Retention Pin for Screwdriver XL25

Assemble the three-part trocar combination (protection sleeve, drill sleeve and trocar) and insert it through the lateral oblique hole in the aiming arm. Make a stab incision and insert the trocar to the bone. Remove the trocar.

Ensure that the drill sleeve is pressed firmly to the near cortex.

Using the drill bit, drill to the desired depth.

Confirm drill bit position.

Ensure that the drill sleeve is pressed firmly to the near cortex and read the measurement from the drill bit at the back of the drill sleeve. This measurement corresponds to the appropriate length locking screw.

■ Note:

If a drill bit was used in the medial oblique hole to stabilize the nail, remove the drill bit and insert the appropriate length locking screw.

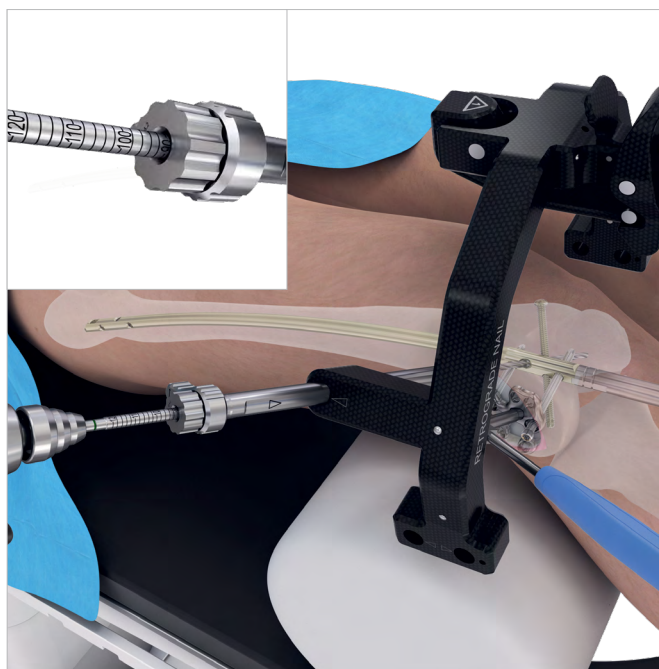
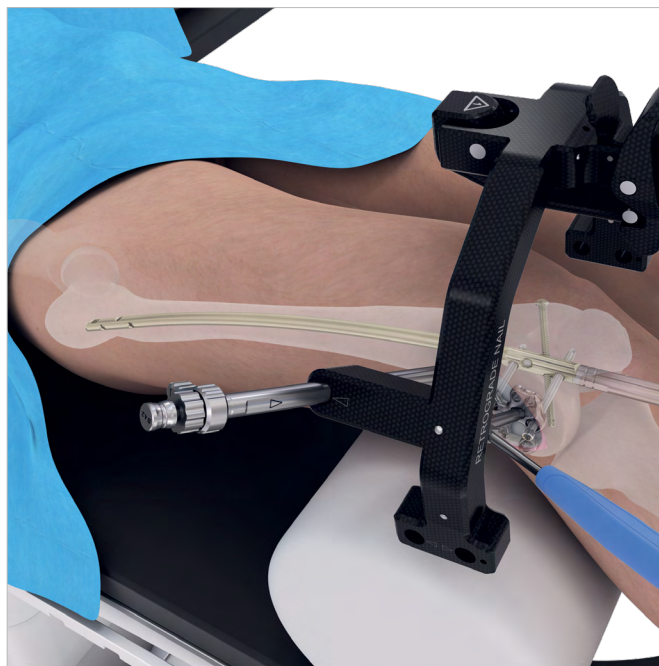

Use the screwdriver to insert the appropriate length locking screw through the protection sleeve, until the head of the locking screw lies against the near cortex.

Remove the protection sleeve and aiming arm.

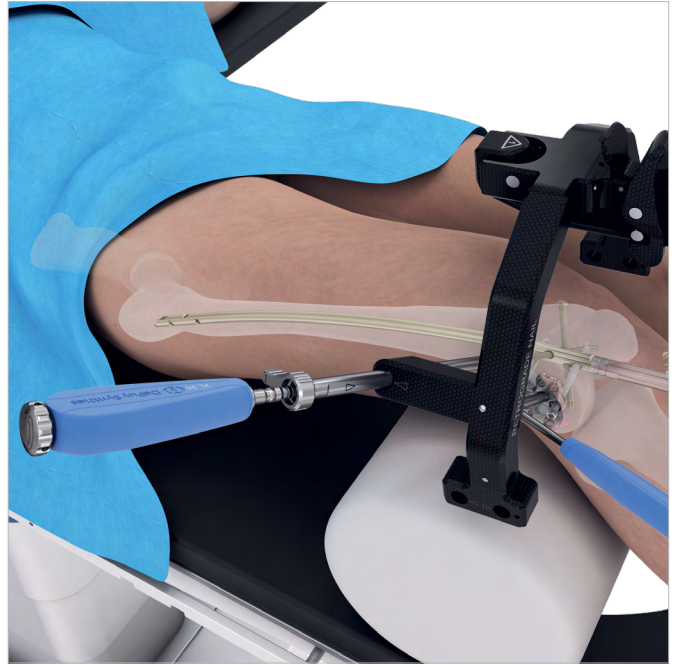

8. Confirm Fit of LAW and Final Tighten 5.0 mm VA Locking Screws

Instruments

03.233.008	Holding Device Locking Pin, for Locking Attachment Washer
03.233.009	Holding Device Handle, for Locking Attachment Washer
03.231.015	SD25 Stardrive Screwdriver Shaft 6 mm Hex Coupling, 180 mm
03.231.018	6Nm Torque Limiting Blue Handle with 6 mm Hex Coupling

Using the Holding Device, manipulate the position of the Locking Attachment Washer until the preferred fit on the bone is achieved.

Note:

The Locking Attachment Washer is designed with two posterior 3.5 mm VA Locking Screw holes that can be contoured in situ.

When the desired fit of the Locking Attachment Washer is achieved, tighten both 5.0 mm VA Locking Screws using the 6Nm torque limiting handle.

Notes:

- Confirm screw position and length prior to final tightening.
- Do not lock the screws to the locking attachment washer under power. Screw engagement and final locking must be done manually with the torque limiting handle (6.0Nm).

Unthread the holding device locking pin from the locking washer and remove the holding device pin from the handle.



9. OPTION: Contour 3.5 mm VA Locking Screw Tabs

Instruments

03.221.251	Bending Driver for 3.5 mm VA Locking Holes
------------	--

The posterior screw holes have a tab feature that enables bending in situ. Use the bending driver in situ to contour the tabs to the desired position. A second bending driver can be used in an adjacent screw hole to provide leverage for contouring.

▲ Caution:

Ensure drill bits and/or screws do not interfere with other medical devices (e.g. knee prosthesis, nail, other screws) and/or critical anatomy (e.g. condylar notch/joint space).

■ Note:

The image shows how contouring the posterior, proximal screw hole may result in the screw crossing the nail anteriorly.



10. Drill and Insert 3.5 mm VA Locking Screw

Instruments

03.133.003	3.5 mm VA Drill Guide
03.133.108	2.8 mm Drill Bit, Quick Coupling, 200 mm, 110 mm Calibration
03.113.019	Screwdriver Shaft Stardrive 165 mm
319.09	Depth Gauge for Small Screws
03.127.016	2.5 Nm Torque Limiting Handle with Quick Coupling

When using the cone end in the desired variable angle locking attachment washer hole, press firmly to ensure the drill guide tip keys into the cloverleaf portion of the variable angle locking screw hole securely. The notches on top of the cone are visual markers for the drill guide tip orientation. The cone will provide a secure window of 30° angulation.

When using the spherical tip end, gently press the instrument into the variable angle hole. The lip portion of the spherical tip end engages with the cloverleaf portion of the hole to provide tactile feedback of the angulations. Continue to provide light pressure while holding the drill guide at the desired angle. The spherical tip end of the drill guide provides freedom to choose angulation. To ensure a precise 15° angulation, use the cone end of the variable angle drill guide.

Using the 2.8 mm drill bit, drill hole.

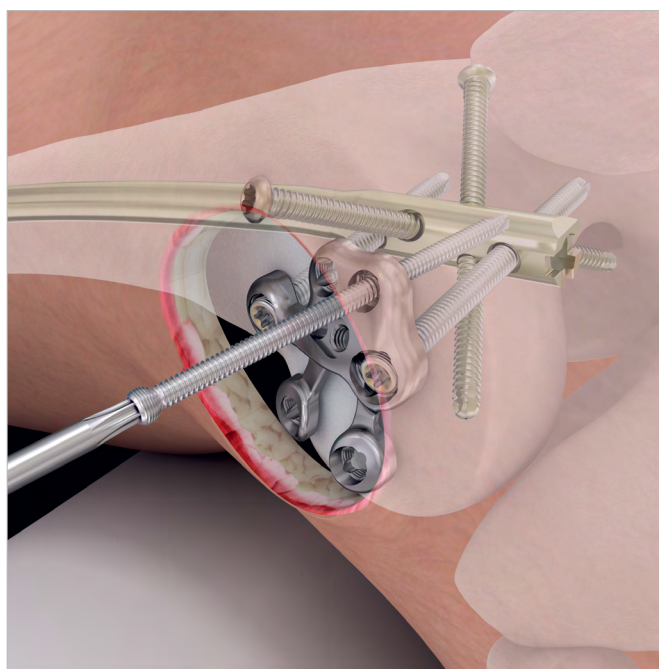

■ **Notes:**

- When drilling the tip of the drill guide should remain fully seated in the hole.
- The drill bit angle may be verified under fluoroscopy to ensure the desired angle has been achieved.
- Radiographic imaging can be used to confirm the distal posterior screw will not be placed in the notch.
- When using the Variable Angle Drill Guides, inserting the screw at the nominal angle will ensure lowest possible profile construct.
- Drill guides are not self-retaining.

The drill bits are calibrated so that depth measurements can be read directly from the drill bit shaft when using the spherical tip end only; calibrations do not apply for the variable angle drill guide cone.

Alternatively, remove the drill bit and drill guide and use the depth gauge to measure for screw length.

■ **Note:**

Calibrated drill bits should not be used to measure screw length through the cone portion of the Variable angle Drill Guides.

Insert a locking screw using the T15 StarDrive screwdriver. Final tightening of the 3.5 mm variable angle locking screws must be done manually with the 2.5 Nm torque limiting handle.

Ensure the screw trajectory is not intersecting the other screw trajectories. Advance the screw and lock it in the locking attachment washer. The torque limiting handle will provide an audible click once torque value is reached indicating that the screw is seated and locked.

■ **Notes:**

- Carefully tighten the locking screw, as excessive force is not necessary to produce effective screw locking.
- Confirm screw position and length prior to final tightening.
- Do not lock the screws to the locking attachment washer under power. Screw engagement and final locking must be done manually with the torque limiting handle (2.5Nm).

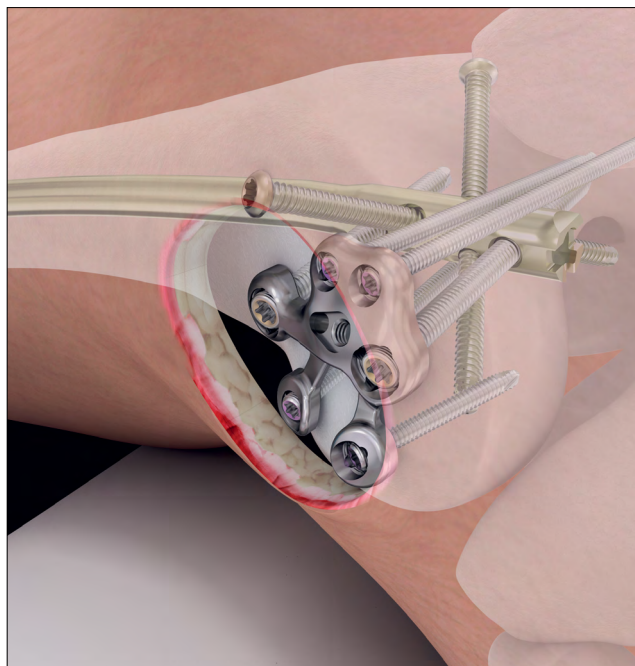

Condylar Nut and Washer

OPTIONS FOR HOW TO USE CONDYLAR NUTS

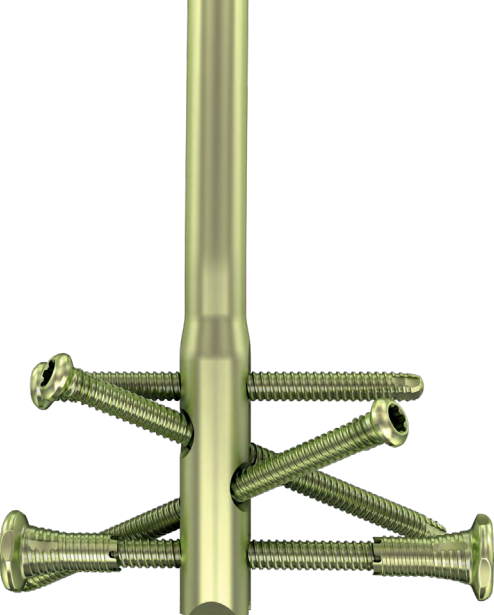

Dual Nuts on Distal Screw

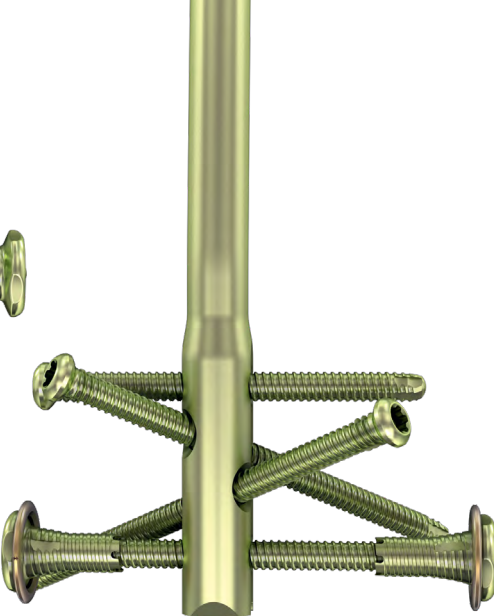

Dual Nuts with Washers on Distal Screw

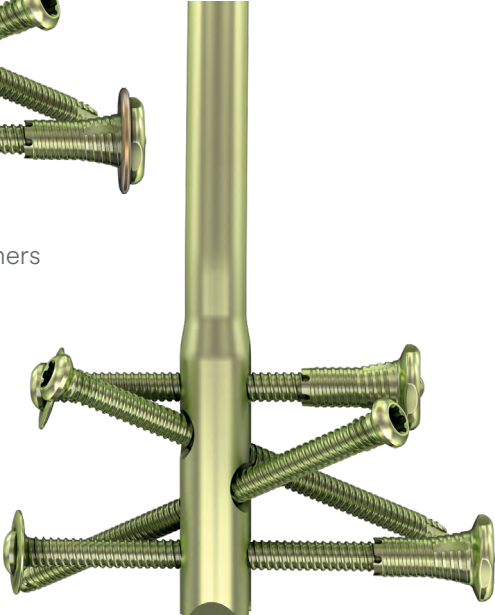

Distal Nut with Washer for Screw Head on both Distal and Proximal Screw

▲ **Precaution:**

Nut and washers are intended for use with standard 5.0 mm screws only (04.045.026 through 04.045.120).

The number of nuts and washers to be used are according to surgeon preference, patient anatomy, or clinical condition.

■ **Note:**

Nut includes a friction feature to secure nut to screw. The surgeon may experience tactile friction during nut insertion onto screw.

The use of nuts and/or washers may be limited in patients with a knee prosthesis, due to interference of the prosthesis, including the prosthesis box, pegs and borders.

The use of nuts may be limited in patients where the nail is inserted deeply into the canal or in a patient with small anatomy, which may result in insufficient insertion depth of the nut.

■ **Note:**

Ensure sufficient insertion depth between nut and nail is available prior to nut insertion to avoid contact between nut and nail. If the nut contacts the nail before being fully seated, the nut may protrude off the bone.

While the actual length of the nut is 15 mm, a minimum depth gauge/drill bit measurement of 20 mm is needed to ensure sufficient insertion depth for the nut.

■ **Note:**

If more than one screw with nut assembly is planned, consider the final position of adjacent screws/ nuts to avoid interference.

TECHNIQUES FOR NUT AND WASHER INSERTION

Two techniques are described for the insertion of the nuts and washers:

1. Nut-Over-Drill Bit Technique
2. Nut-Over-Screw Technique

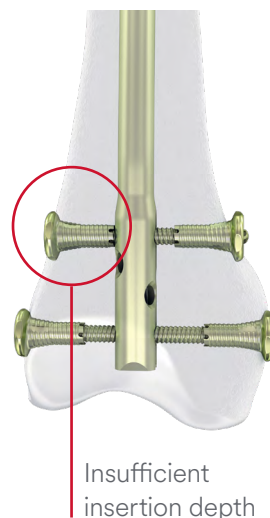
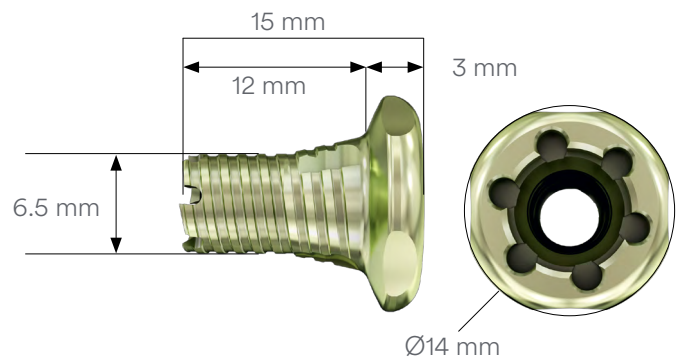

Confirm position of nuts and Lock Nail in position

Instruments

03.045.019	Protection Sleeve, Ø 11/8
03.045.020	Drill Sleeve, Ø 4.2 mm
03.010.070	4.2 mm Trocar 210 mm
03.045.022	Drill Bit, Calibrated, Ø 4.2 mm Extra-Long
03.045.001	Screwdriver XL25
03.045.002	Retention Pin for Screwdriver XL25

Lock the nail to the distal fragment to limit motion of the nail relative to the distal fragment.

Assemble the three-part trocar combination (protection sleeve, drill sleeve and trocar) and insert it through the medial oblique hole in the aiming arm. Make a stab incision and insert the trocar to the bone. Remove the trocar.

Ensure that the drill sleeve is pressed firmly to the near cortex. Using the drill bit, drill to the desired depth and confirm drill bit position after drilling.

Confirm drill bit position.

Ensure that the drill sleeve is pressed firmly to the near cortex and read the measurement from the drill bit at the back of the drill sleeve. This measurement corresponds to the appropriate length locking screw.

Remove the drill bit and the drill sleeve.

Use the screwdriver to insert the appropriate length locking screw through the protection sleeve, until the head of the locking screw lies against the near cortex.

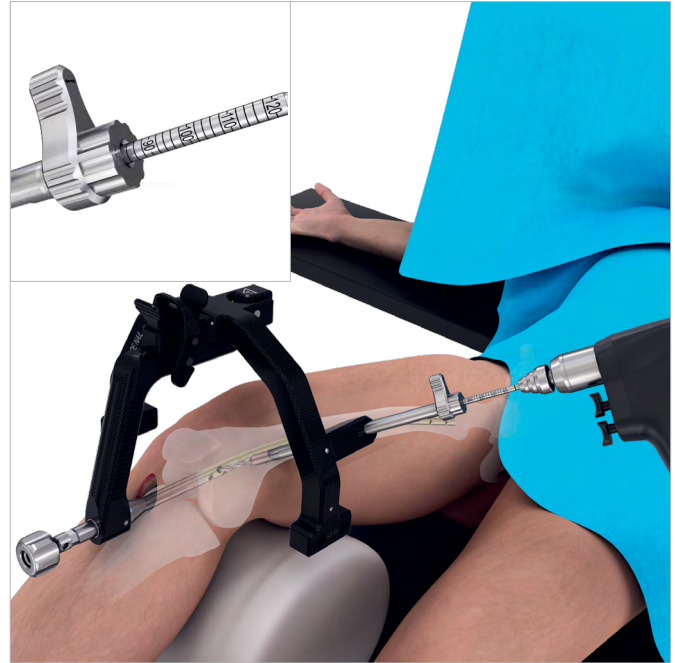

Condylar Nut and Washer: Nut-Over-Drill Bit Technique

1. Drill and Determine length of locking screw

Instruments

03.233.006	Aiming Arm Radiolucent
03.045.019	Protection Sleeve, Ø 11/8
03.045.020	Drill Sleeve, Ø 4.2 mm
03.010.070	4.2 mm Trocar 210 mm
03.045.022	Drill Bit, Calibrated, Ø 4.2 mm Extra-Long

Assemble the three-part trocar combination (protection sleeve, drill sleeve and trocar) and insert it through the desired hole in the aiming arm. Make a stab incision and insert the trocar to the bone. Remove the trocar.

Ensure that the drill sleeve is pressed firmly to the near cortex. Using the drill bit, drill through both cortices until the tip of the drill bit penetrates the far cortex.

Confirm drill bit position.

Ensure that the drill sleeve is pressed firmly to the near cortex and read the measurement from the drill bit at the back of the drill sleeve. This measurement corresponds to the appropriate length locking screw.

Keep the drill bit in position in the bone. Decouple the drill bit from the power tool.

Confirm a minimum distance of 48 mm is measured bicortically with the drill bit/depth gauge to ensure sufficient insertion depth for each nut.

■ Note:

Consider anatomy and/or position of the nail in the bone. A minimum distance of 20 mm measured with the drill bit/depth gauge from the surface of the bone to the outer surface of the nail is needed to ensure the nut does not contact the nail at final tightening.

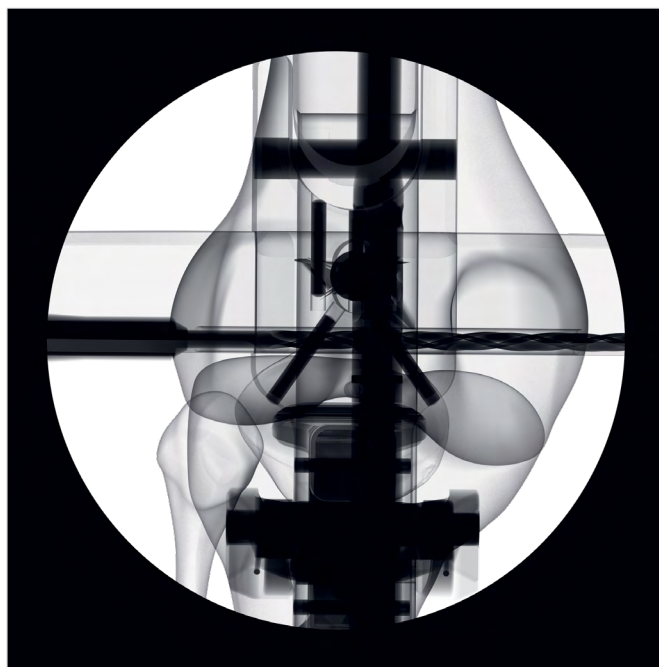
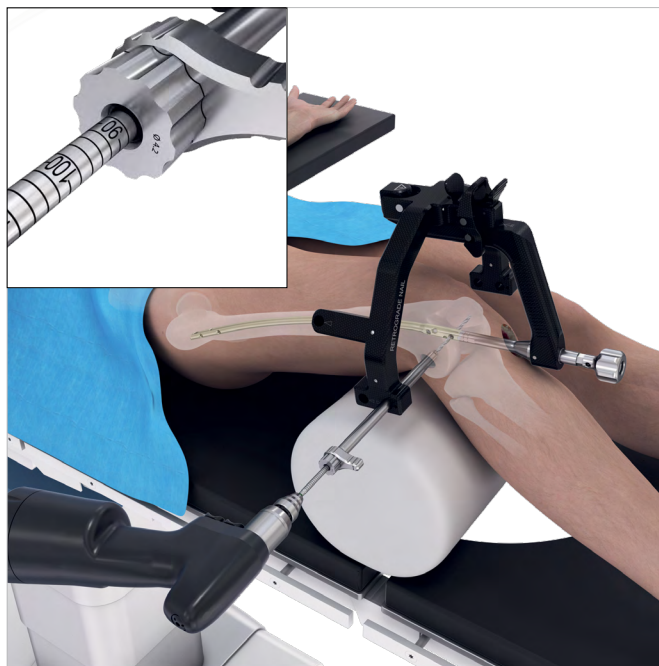

2. Insert Distal Nut

Instruments

03.045.033	Driver for Nut
03.045.001	Screwdriver XL25
03.045.002	Retention Pin for Screwdriver XL25

At the contralateral position in the aiming arm, insert the nut driver partially through the aiming arm. Attach the nut to the nut driver.

■ Note:

If using the washer for nut, position the washer over the nut prior to advancing the nut to the bone.

Advance nut to the bone, ensuring alignment with the tip of the drill bit.

While holding the drill bit in position, tighten nut with nut driver until seated.

Keep nut driver engaged in nut. Remove the drill bit.

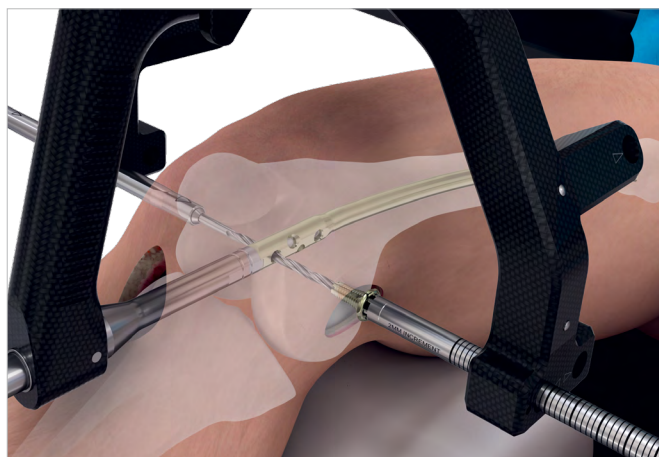
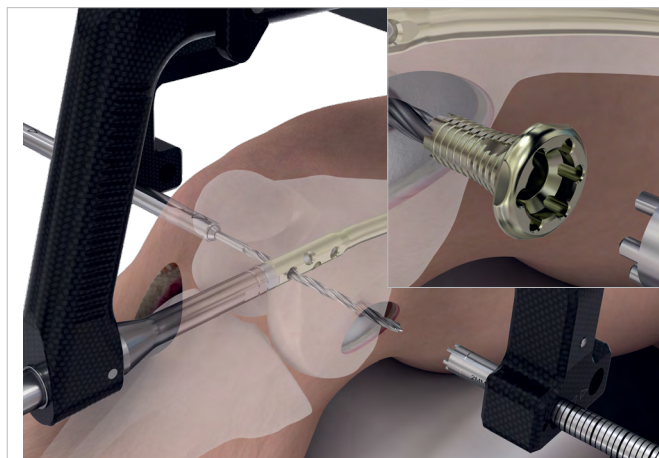

3a. For Single, Distal Nut Configuration: Insert locking screw

Instruments

03.045.001	Screwdriver XL25
03.045.002	Retention Pin for Screwdriver XL25
03.045.019	Protection Sleeve, Ø 11/8

To place the washer for screw, retract the protection sleeve. Insert the appropriate length locking screw through the protection sleeve, exposing the screw tip.

Position the washer for screw over the screw tip. Continue insertion until the screw head lies against the near cortex.

Keep screwdriver engaged with screw.

After insertion of the screw through the nail, use radiographic imaging to ensure the tip of the screw is aligned with the nut in the bone.

Use the nut driver to provide counter-torque to the nut while inserting the screw through the nut. Continue insertion of the screw until seated.

■ Note:

The poly inlay in the nail locks the screw in position, inhibiting translation of the screw through the nail. To reduce the potential of driving the screw and nail out of position and/or affecting bony reduction, use the screwdriver to provide counter-torque during nut insertion.

Remove nut driver, screwdriver, and protection sleeve.

Repeat Steps 1 through 4 for additional nuts, if desired.

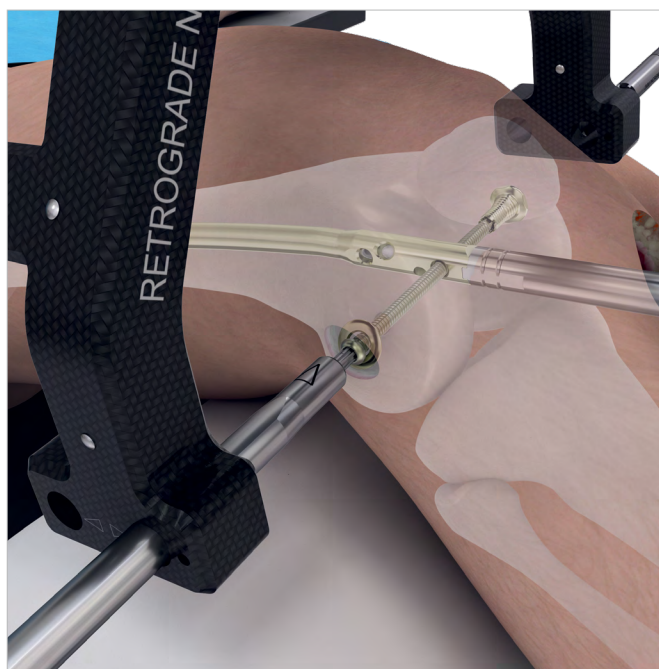
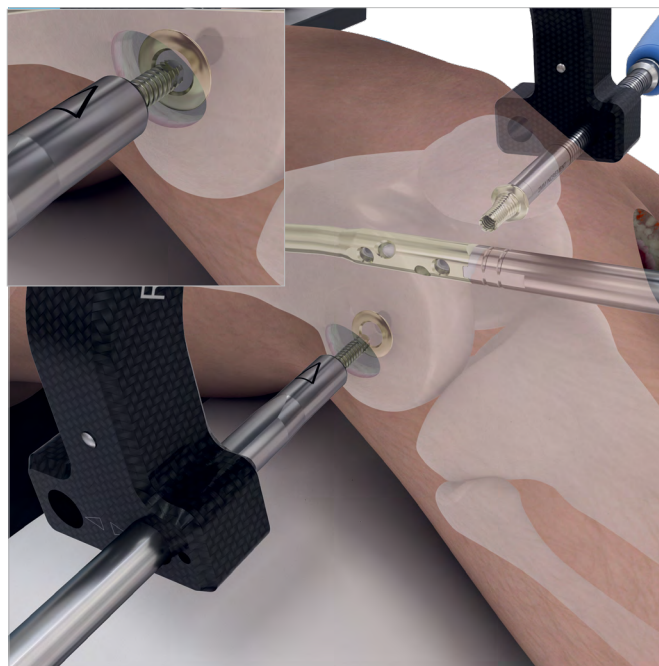

3b. For Dual Nut Configuration: Insert locking screw

Instruments

03.045.001	Screwdriver XL25
03.045.002	Retention Pin for Screwdriver XL25
03.045.019	Protection Sleeve, Ø 11/8

With the retention pin inserted into the screwdriver, insert the screwdriver into the screw head recess. Thread the retention pin into the screw head until secure.

Using the protection sleeve at the desired screw hole position in the aiming arm, secure the protection sleeve in a retracted position in the aiming arm to allow attachment of the nut to the screw tip.

■ Note:

If using the washer for nut, position the washer over the nut prior to advancing the screw and nut assembly to the bone.

■ Note:

Prior to inserting nut into bone, forceps can be used to hold nut during screw insertion until the screw head is seated in the nut.

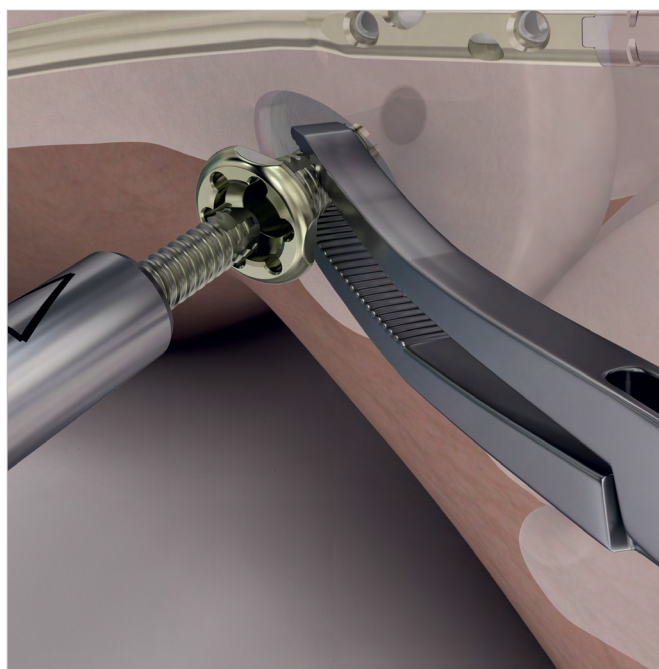
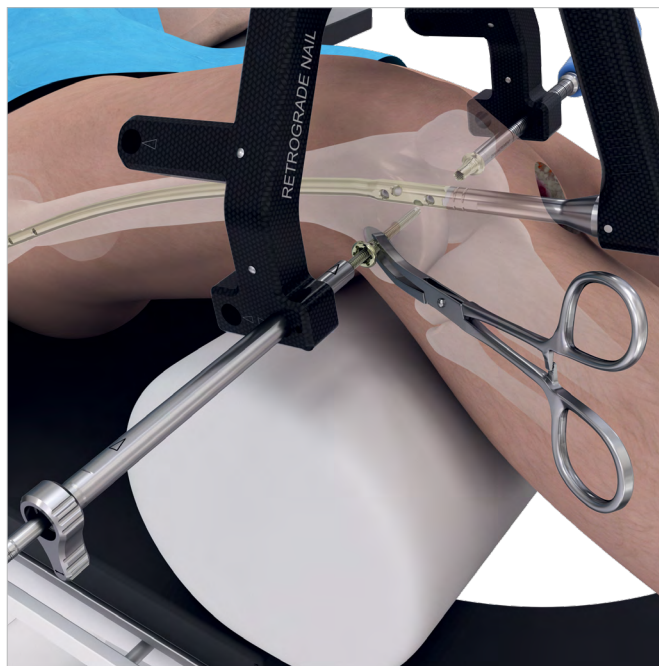

Use the screwdriver to insert the appropriate length locking screw through the protection sleeve.

After insertion of the screw through the nail, use radiographic imaging to ensure the tip of the screw is aligned with the nut in the bone.

Use the nut driver to provide counter-torque to the nut while inserting the screw through the nut. Continue insertion of the screw and nut until seated.

■ **Note:**

The poly inlay in the nail locks the screw in position, inhibiting translation of the screw through the nail. To reduce the potential of driving the screw and nail out of position and/or affecting bony reduction, use the screwdriver to provide counter-torque during nut insertion.

Remove nut, screwdriver and protection sleeve.

Repeat Steps 1 through 3 for additional nuts, if desired.

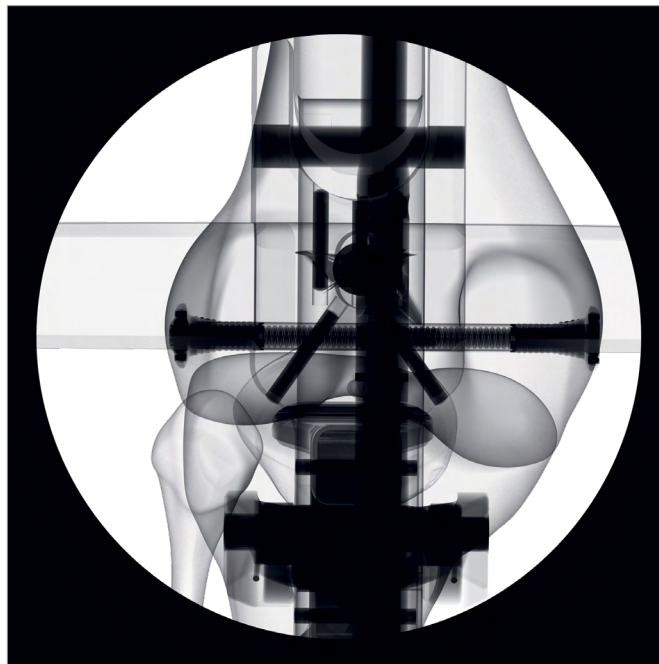

Condylar Nut and Washer: Nut-Over-Screw Technique

1. Drill and Determine screw length and nut insertion depth

Instruments

03.233.006	Aiming Arm Radiolucent
03.045.019	Protection Sleeve, Ø 11/8
03.045.020	Drill Sleeve, Ø 4.2 mm
03.010.070	4.2 mm Trocar 210 mm
03.045.022	Drill Bit, Calibrated, Ø 4.2 mm Extra-Long

Assemble the three-part trocar combination (protection sleeve, drill sleeve and trocar) and insert it through the desired hole in the aiming arm. Make a stab incision and insert the trocar to the bone. Remove the trocar.

Ensure that the drill sleeve is pressed firmly to the near cortex. Using the drill bit, drill through both cortices until the tip of the drill bit penetrates the far cortex.

Confirm drill bit position.

Ensure that the drill sleeve is pressed firmly to the near cortex and read the measurement from the drill bit at the back of the drill sleeve. This measurement corresponds to the appropriate length locking screw.

Confirm a minimum distance of 48 mm is measured bicortically with the drill bit/depth gauge to ensure sufficient insertion depth for each nut.

Remove drill bit.

■ Note:

Consider anatomy and/or position of the nail in the bone. A minimum distance of 20 mm measured with the drill bit/depth gauge from the surface of the bone to the outer surface of the nail is needed to ensure the nut does not contact the nail at final tightening.



2. OPTION: Countersink for Nut

Instruments

03.045.034 Countersink 7.4 mm, Quick Coupling,

Countersink can be used to ease insertion of nut in hard bone.

Use countersink under power through aiming arm at the location of the desired screw hole location.
Drill with countersink until the stop on the countersink contacts the cortical surface.

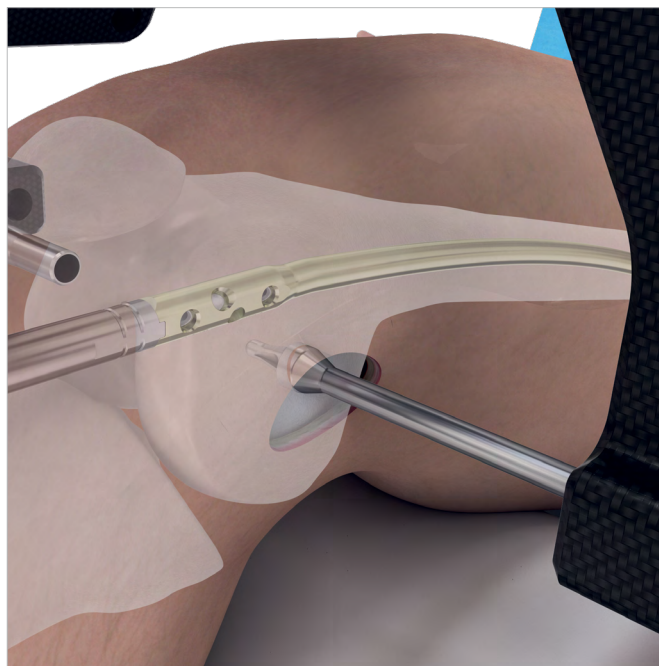

3a. For Single, Distal Nut Configuration: Insert locking screw

Instruments

03.045.001	Screwdriver XL25
03.045.002	Retention Pin for Screwdriver XL25
03.045.019	Protection Sleeve, Ø 11/8

With the retention pin inserted into the screwdriver, insert the screwdriver into the screw head recess. Thread the retention pin into the screw head until secure.

To place the washer for screw, retract the protection sleeve. Insert the appropriate length locking screw through the protection sleeve, exposing the screw tip.

Position the washer for screw over the screw tip. Continue insertion of screw until the screw head lies against the near cortex.

Keep screwdriver engaged with screw.

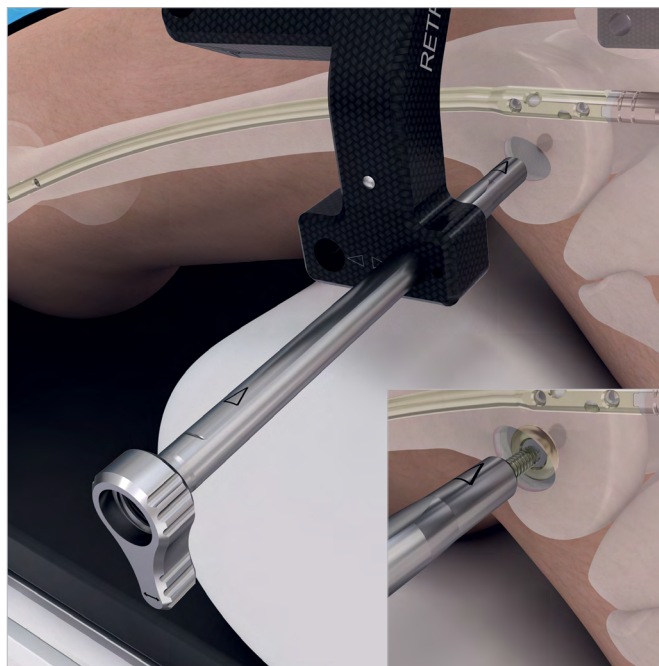

3b. For Dual Nut Configuration: Insert locking screw

Instruments

03.045.001	Screwdriver XL25
03.045.002	Retention Pin for Screwdriver XL25
03.045.019	Protection Sleeve, Ø 11/8

With the retention pin inserted into the screwdriver, insert the screwdriver into the screw head recess. Thread the retention pin into the screw head until secure.

Using the protection sleeve at the desired screw hole position in the aiming arm, secure the protection sleeve in a retracted position in the aiming arm to allow attachment of the nut to the screw tip.

Use the screwdriver to insert the appropriate length locking screw through the protection sleeve until the tip of the screw is visible. Thread nut onto tip of screw until secure.

Advance screw and nut assembly and protection sleeve to the bone.

■ **Note:**

If using the washer for nut, position the washer over the nut prior to advancing the screw and nut assembly to the bone.

Proceed with inserting screw and nut until the nut is seated in the bone and the screw head is seated within the nut.

■ **Note:**

Prior to inserting nut into bone, forceps can be used to hold nut during screw insertion until the screw head is seated in the nut.

Keep screwdriver engaged with screw.

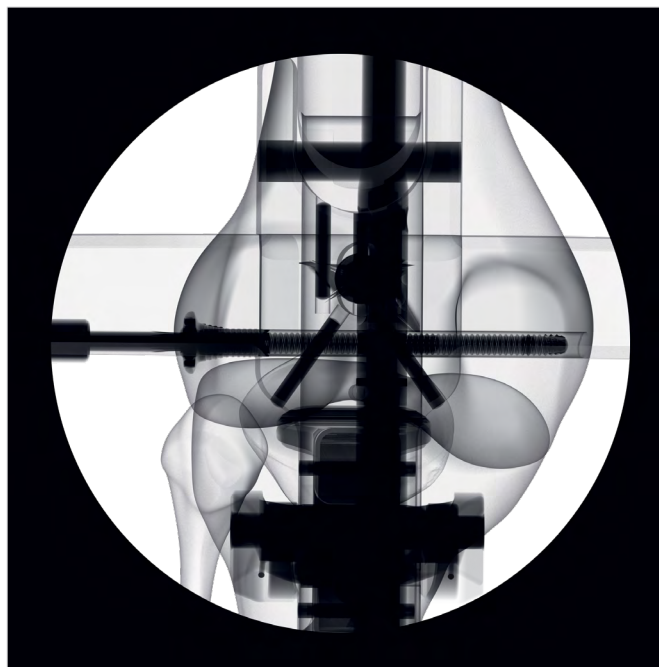
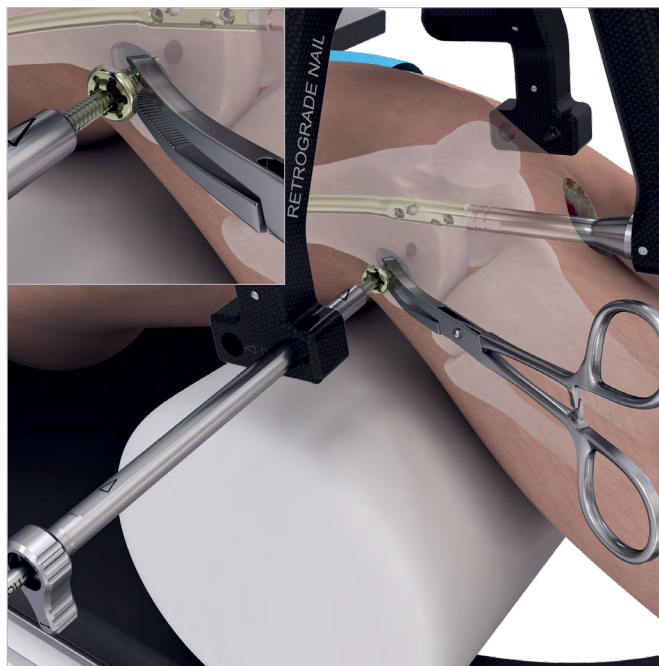

4. Insert Distal Nut and Final Tighten

Instruments

03.045.033	Driver for Nut
03.045.001	Screwdriver XL25
03.045.002	Retention Pin for Screwdriver XL25

At the contralateral position in the aiming arm, insert the nut driver partially through the aiming arm.

Attach the nut to the nut driver.

■ Note:

If using the washer for nut, position the washer over the nut prior to advancing the nut to the bone.

Advance nut to the bone, ensuring alignment with the screw tip.

While holding the screwdriver in position, tighten nut with nut driver until seated.

■ Note:

The poly inlay in the nail locks the screw in position, inhibiting translation of the screw through the nail. To reduce the potential of driving the screw and nail out of position and/or affecting bony reduction, use the screwdriver to provide counter-torque during nut insertion.

Remove nut driver, screwdriver, and protection sleeve.

Repeat Steps 1 through 4 for additional nuts, if desired.

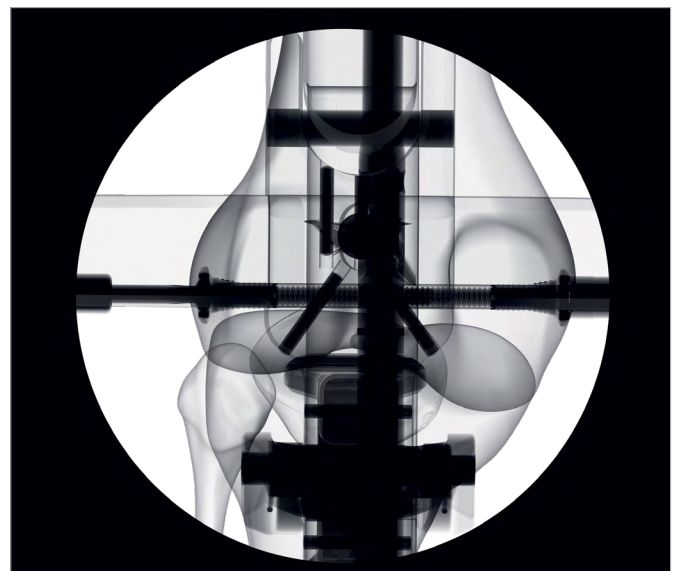
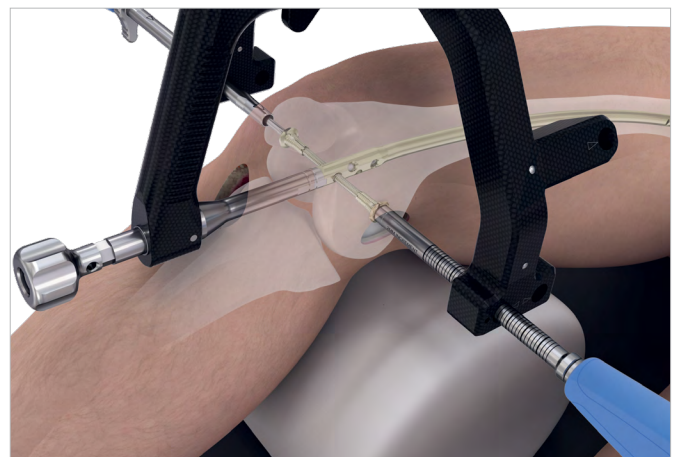
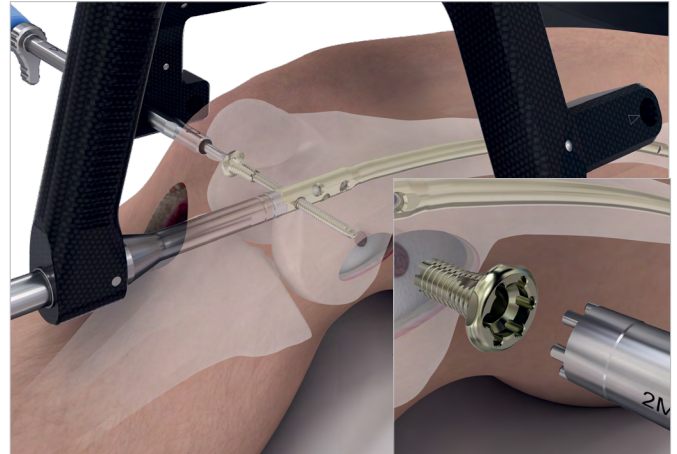

Insert End Cap

Option: Insert end cap

Instruments

03.045.001	Screwdriver XL25
03.045.002	Retention Pin for Screwdriver XL25

Remove the connecting screw.

For 0 mm end cap, the insertion handle can remain in place to help align the end cap to the nail. The end cap fits through the barrel of the insertion handle. Insert end cap through barrel of insertion handle and tighten until secure.

The 5 mm and 10 mm end caps do not fit through the barrel of the insertion handle. To insert end cap, remove insertion handle. Insert end cap and tighten until secure.

If desired, the end cap can be locked to the screwdriver by use of the retention pin. To do so, slide the retention pin through the back of the screwdriver until it stops. Further advance it by turning it clockwise, until its tip extends out of the tip of the screwdriver.



Screw Removal

1. Additional Instruments for Screw Removal

Instruments

03.045.030	Extractor Shaft for XL25 and SD25
03.045.031	Curette for XL25
03.045.032	Extraction Screw, conical
03.900.001	Sharp Hook, straight, length 150 mm

If screw heads are overgrown or the recess is damaged, additional instruments are available for screw removal. They can be used with all XL25 screw types.

1. Clear recess and screw head with the curette. The curette turns counter-clockwise
2. Use the sharp hook to clean out any remaining tissue
3. Engage the extractor shaft to remove the screw
4. If 3. does not work, use the conical extraction screw to remove the screw. The conical extraction screw turns counter-clockwise

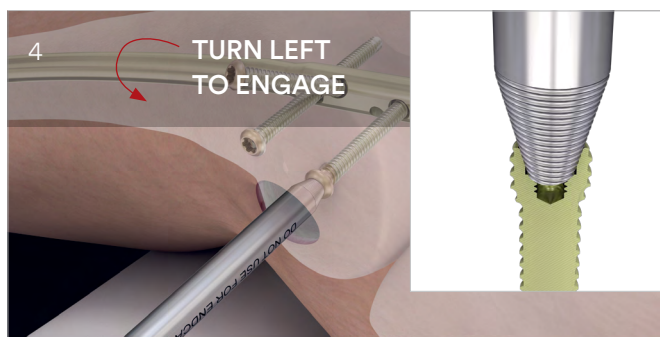
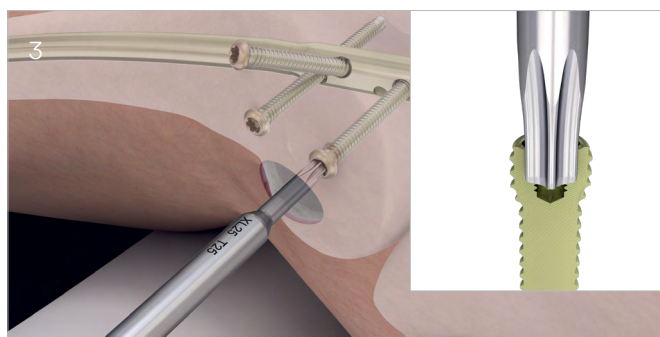
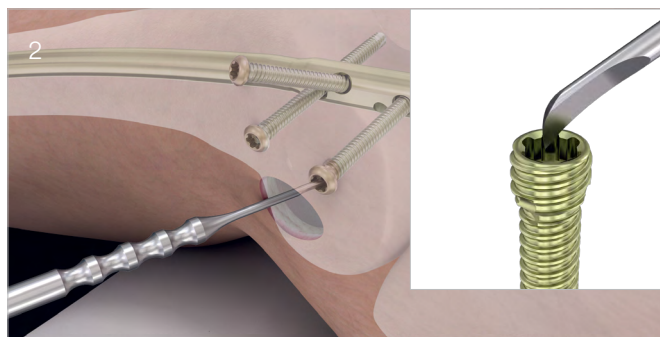
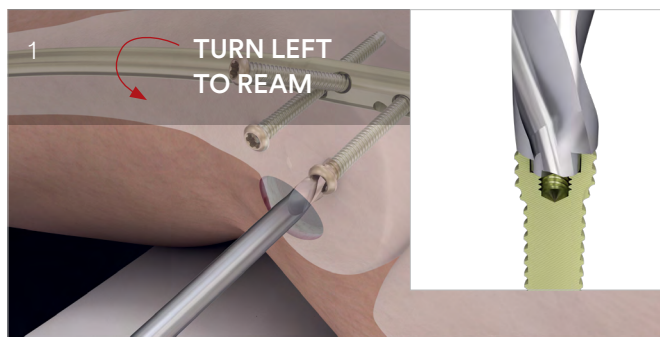

Implant Removal

1. Remove end cap

Instruments

03.045.001	Screwdriver XL25
03.045.002	Retention Pin for Screwdriver XL25

Clear the recess of the end cap of any tissue ingrowth.

Remove the end cap with the Screwdriver.



2. Remove screws

Instruments

03.045.001	Screwdriver XL25
03.045.002	Retention Pin for Screwdriver XL25

Clear the recess of the locking screws of any In-grown tissue.

Remove all locking screws except one to keep nail from rotating during insertion of extraction screw. The most distal locking screw should be removed in order to engage the extraction screw.

Remove the nuts, washers, and/or locking attachment washer if used.

Note:

The XL25 recess is compatible with StarDrive T25 screwdrivers.

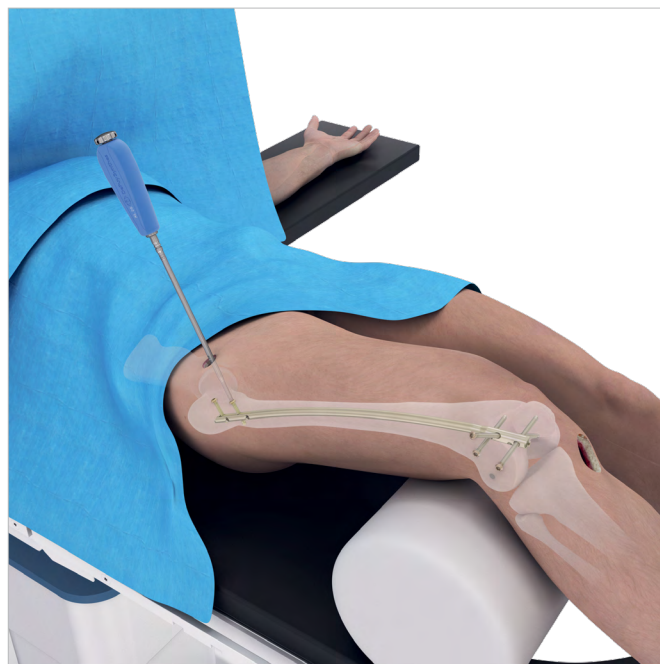

3. Attach extraction screw and hammer guide

Instruments

03.010.000	Conical Extraction Screw for Ti Femoral and Tibial Nails
------------	--

Alternative Instrument

357.133	Extraction Screw for Ti Femoral and Tibial Nails
---------	--

Thread the extraction screw into the nail and tighten it to prevent rotation or displacement of the nail.

Attach the hammer guide to the extraction screw.

Remove the remaining locking screw.



4. Remove nail

Instruments

03.010.522	Spiral Combination Hammer, 500 Grams
------------	--------------------------------------

Extract the nail by applying gentle blows with the slide/ fixed hammer.



Implants

RFN-Advanced Retrograde Femoral Nailing System

Features

Universal design for left or right femur

Material

Titanium-6% Aluminum-4% Vanadium alloy

Diameters

Ø 9 mm, Ø 10 mm, Ø 11 mm, Ø 12 mm,

Distal end diameter is 12 mm, with flats medially and laterally to reduce width to 11.2 mm

Ø 14 mm

Distal end diameter is 14mm (no flats)

Lengths

160 mm through 480 mm

Screws

- Ø 5.0 mm Locking Screws for IM Nails
- Ø 5.0 mm Low Profile Locking Screws for IM Nails

Cross Section

- 9 mm – 10 mm are round
- 11 mm – 14 mm are fluted

Curvature

1.0 m Radius of curvature

Short nails (160 mm and 200 mm) do not have a radius of curvature.

Bend

Offered in a standard bend and a periprosthetic bend, for patients with knee prosthesis

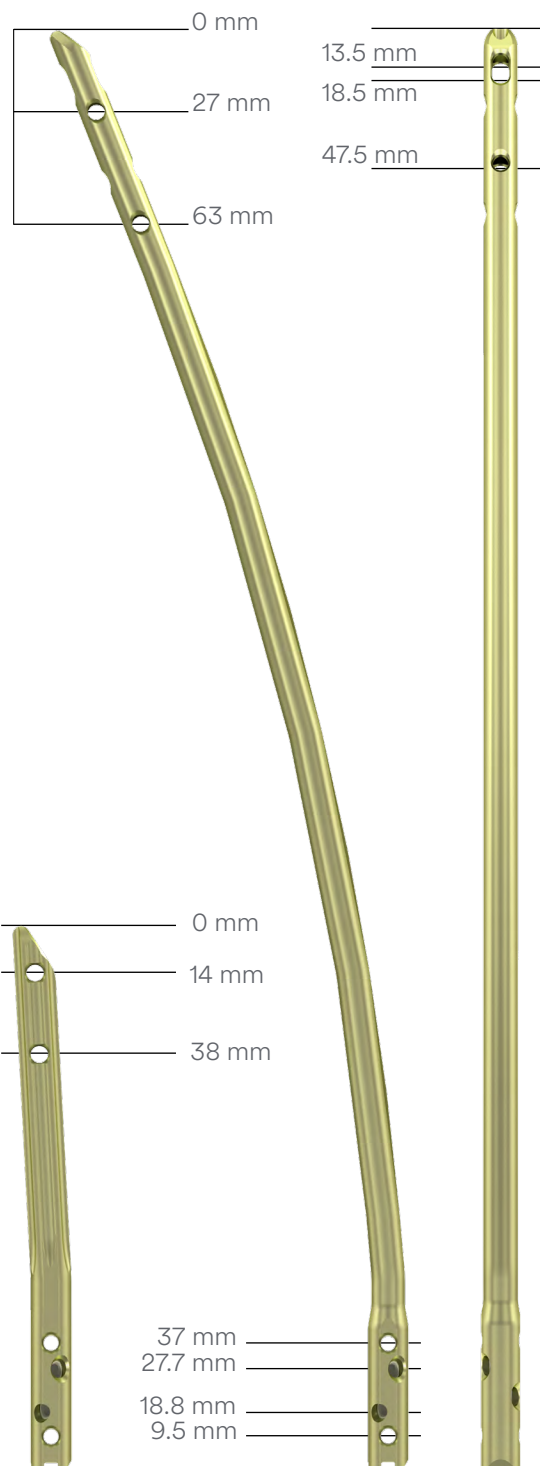

Length (mm)	9 mm dia.	10 mm dia	11 mm dia	12 mm dia
160	04.233.916S	04.233.016S	04.233.116S	04.233.216S
200	04.233.920S	04.233.020S	04.233.120S	04.233.220S
240	04.233.924S	04.233.024S	04.233.124S	04.233.224S
280	04.233.928S	04.233.028S	04.233.128S	04.233.228S
300	04.233.930S	04.233.030S	04.233.130S	04.233.230S
320	04.233.932S	04.233.032S	04.233.132S	04.233.232S
340	04.233.934S	04.233.034S	04.233.134S	04.233.234S
360	04.233.936S	04.233.036S	04.233.136S	04.233.236S
380	04.233.938S	04.233.038S	04.233.138S	04.233.238S
400	04.233.940S	04.233.040S	04.233.140S	04.233.240S
420	04.233.942S	04.233.042S	04.233.142S	04.233.242S
440	04.233.944S	04.233.044S	04.233.144S	04.233.244S
460	04.233.946S	04.233.046S	04.233.146S	04.233.246S
480	04.233.948S	04.233.048S	04.233.148S	04.233.248S

Length (mm)	14 mm dia.
280	04.233.428S
300	04.233.430S
320	04.233.432S
340	04.233.434S
360	04.233.436S
380	04.233.438S
400	04.233.440S
420	04.233.442S
440	04.233.444S
460	04.233.446S
480	04.233.448S

Standard Bend Nail



Length (mm)	9 mm dia.	10 mm dia	11 mm dia	12 mm dia
160	04.233.917S	04.233.017S	04.233.117S	04.233.217S
200	04.233.921S	04.233.021S	04.233.121S	04.233.221S
240	04.233.925S	04.233.025S	04.233.125S	04.233.225S
280	04.233.929S	04.233.029S	04.233.129S	04.233.229S
300	04.233.931S	04.233.031S	04.233.131S	04.233.231S
320	04.233.933S	04.233.033S	04.233.133S	04.233.233S
340	04.233.935S	04.233.035S	04.233.135S	04.233.235S
360	04.233.937S	04.233.037S	04.233.137S	04.233.237S
380	04.233.939S	04.233.039S	04.233.139S	04.233.239S
400	04.233.941S	04.233.041S	04.233.141S	04.233.241S
420	04.233.943S	04.233.043S	04.233.143S	04.233.243S
440	04.233.945S	04.233.045S	04.233.145S	04.233.245S
460	04.233.947S	04.233.047S	04.233.147S	04.233.247S
480	04.233.949S	04.233.049S	04.233.149S	04.233.249S

Periprosthetic Bend Nail

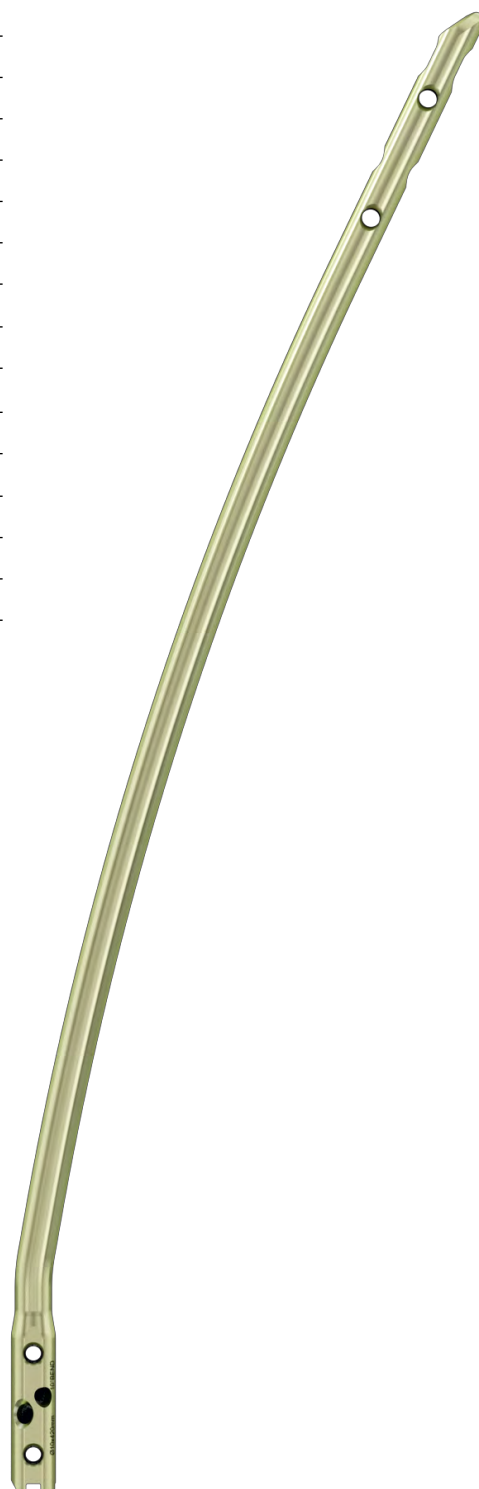

Implants

RFN-Advanced Retrograde Femoral Nailing System

Locking Screw for Medullary Nails, Ø 5 mm

- Titanium alloy
- Lengths 26 mm– 90 mm (2 mm increments)
- Lengths 90 mm – 120 mm (5 mm increments)
- Fully Threaded
- Self-tapping, blunt tip
- XL25 Stardrive Recess with threaded retention

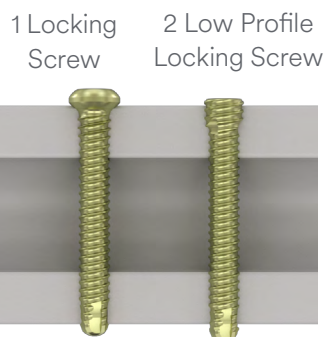

Length (mm)	Locking Screws*	Low Profile Locking Screws*
26	04.045.026	04.045.326
28	04.045.028	04.045.328
30	04.045.030	04.045.330
32	04.045.032	04.045.332
34	04.045.034	04.045.334
36	04.045.036	04.045.336
38	04.045.038	04.045.338
40	04.045.040	04.045.340
42	04.045.042	04.045.342
44	04.045.044	04.045.344
46	04.045.046	04.045.346
48	04.045.048	04.045.348
50	04.045.050	04.045.350
52	04.045.052	04.045.352
54	04.045.054	04.045.354
56	04.045.056	04.045.356
58	04.045.058	04.045.358
60	04.045.060	04.045.360
62	04.045.062	04.045.362
64	04.045.064	04.045.364

Length (mm)	Locking Screws*	Low Profile Locking Screws*
66	04.045.066	04.045.366
68	04.045.068	04.045.368
70	04.045.070	04.045.370
72	04.045.072	04.045.372
74	04.045.074	04.045.374
76	04.045.076	04.045.376
78	04.045.078	04.045.378
80	04.045.080	04.045.380
82	04.045.082	04.045.382
84	04.045.084	04.045.384
86	04.045.086	04.045.386
88	04.045.088	04.045.388
90	04.045.090	04.045.390
95	04.045.095	04.045.395
100	04.045.100	04.045.400
105	04.045.105	04.045.405
110	04.045.110	04.045.410
115	04.045.115	04.045.415
120	04.045.120	04.045.420

*All screws available non-sterile or in sterile tube packaging (corresponding article number with suffix "TS").
Additionally all screws 84mm or longer also available in standard sterile packaging (corresponding article number with suffix "S").

RFN-Advanced Retrograde Femoral Nailing System

Titanium End Caps, with XL25 StarDrive Recess, for IM Nails

- Titanium alloy
- End cap protects the nail connection threads from bone ingrowth and facilitates nail removal
- XL25 threaded recess facilitates secure end cap pick-up and insertion
- 0 mm sits flush with end of nail
- 5 mm and 10 mm extend nail height if nail is overinserted



	Extension (mm)
04.233.000S	0
04.233.005S	5
04.233.010S	10

RFN-Advanced Retrograde Femoral Nailing System

Titanium Nuts and Washers for Locking Screws

- Washers are made from Titanium, Nut is made from Titanium alloy
- Nut is inserted over standard locking screws, either at the screw tip or screw head
- Washer for Nut, 1.1 mm thickness, to increase overall diameter to 17 mm
- Washer for Screw, 1.2 mm thickness, to increase diameter to 14 mm, without use of nut

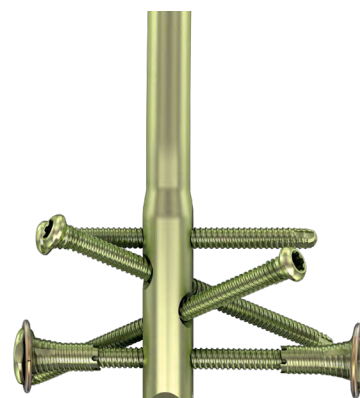

04.045.780S	Washer for Screw
04.045.781S	Nut
04.045.782S	Washer for Nut

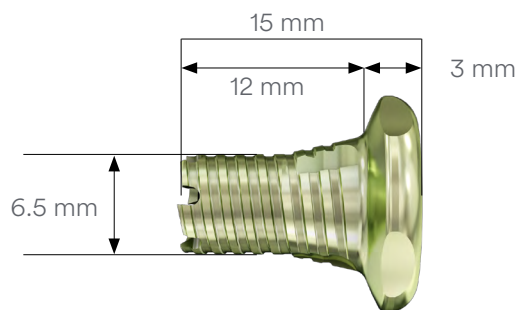
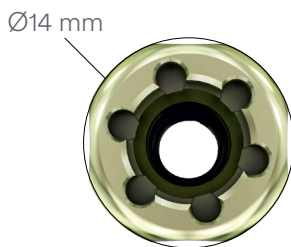
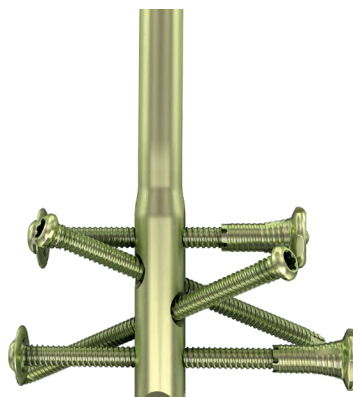

RFN-Advanced Retrograde Femoral Nailing System

Locking Attachment Washer for RFN-A

- Stainless Steel
- Use with 5.0 mm Variable Angle Locking Screws to interlock with nail
- Additional 3.5 mm Variable Angle Locking Screws can be used to increase screw fixation in the distal femur
- Available in left and right versions
- Available in two shapes designed to match the nail bend
- Anatomically contoured for improved fit
- In situ benders to provide additional contouring

02.233.100S	5°	Right
02.233.101S	5°	Left
02.233.104S	10°	Right
02.233.105S	10°	Left



02.233.100S



02.233.101S



02.233.104S



02.233.105S

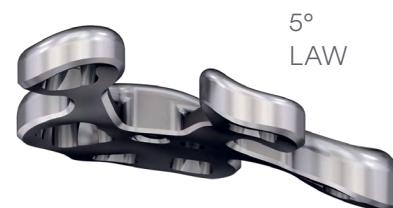

10° LAW has a larger offset out-of-plane between 5.0 VA Locking holes to account for transition from lateral epicondyle proximally.



RFN-Advanced Retrograde Femoral Nailing System

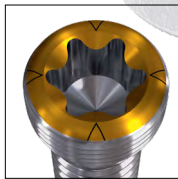
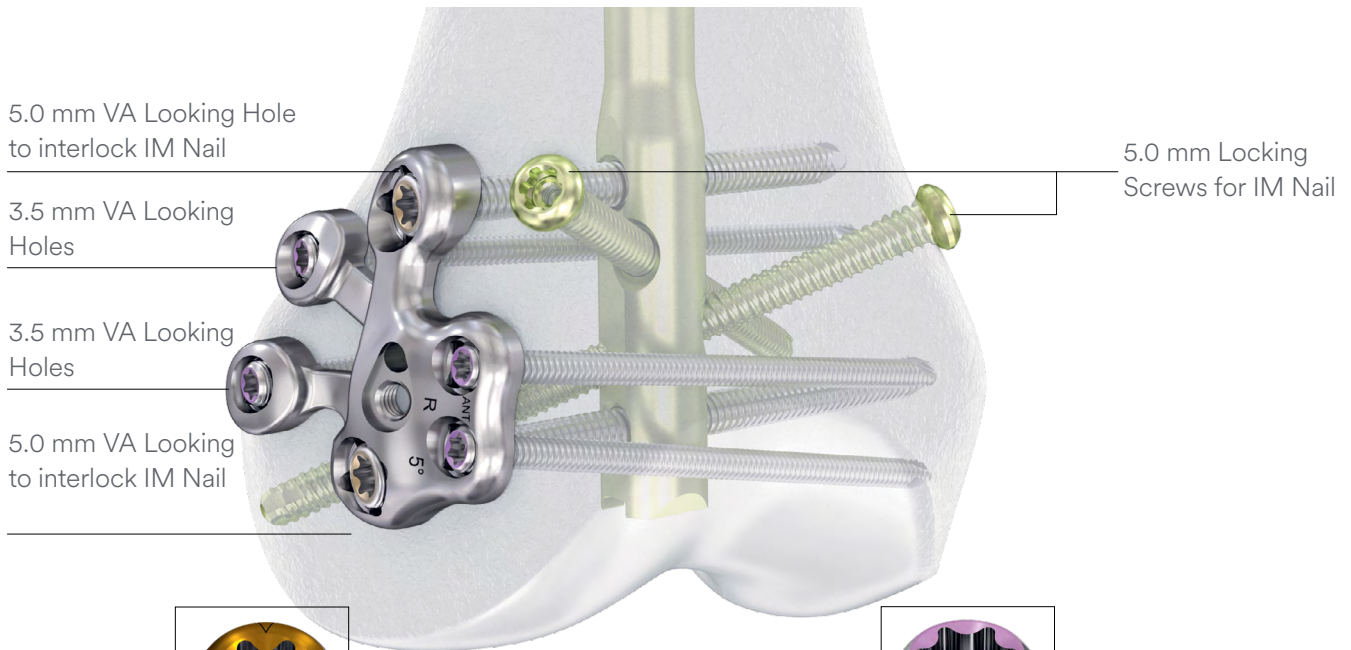

OPTILINK 5.0 mm VA Locking Screws

Length* (mm)	Locking Screws
50	42.231.250
55	42.231.255
60	42.231.260
65	42.231.265
70	42.231.270
75	42.231.275
80	42.231.280
85	42.231.285
90	42.231.290
95	42.231.295S
100	42.231.300S
105	42.231.305S



3.5 mm Variable Angle Locking Screws

Length* (mm)	Locking Screws	Length (mm)	Locking Screws
36	02.127.136	56	02.127.156
38	02.127.138	58	02.127.158
40	02.127.140	60	02.127.160
42	02.127.142	65	02.127.165
44	02.127.144	70	02.127.170
46	02.127.146	75	02.127.175
48	02.127.148	80	02.127.180
50	02.127.150	85	02.127.185
52	02.127.152	90	02.127.190
54	02.127.154	95	02.127.195

*Smaller screw lengths also available. Screws are also available sterile packed. Add "TS" for sterile tube packaging.

Instruments

Retrograde Femoral Nailing Advance System Instruments

03.233.000 Periprosthetic Wire Guide



03.233.001 Drill Bit Ø 12.8 mm, cannulated f/Large Quick Coupling



03.233.002 Drill Bit Ø 11.2 mm, cannulated f/Large Quick Coupling



03.233.003 Connecting Screw



03.233.004 Nail Assembly Instrument



03.233.005 Insertion Handle, Radiolucent



Retrograde Femoral Nailing Advance System Instruments

03.233.006 Aiming Arm, Radiolucent





03.233.008 Holding Device Locking Pin for Locking Attachment Washer





03.233.009 Holding Device Handle for Locking Attachment Washer



Alternative Instruments

Alternative Instruments	
03.010.104	03.010.101
	

Alternative Instruments	
03.045.022 for screw lengths up to 120 mm	03.010.061 for screw lengths up to 100 mm
	

03.043.001	393.100
	

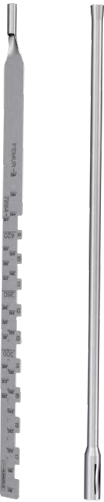
03.045.035 + 03.045.036	351.717 + 351.719
	

Instruments

03.010.070 4.2 mm Trocar 210 mm



03.010.104 4.2 mm, three-fluted Drill Bit Quick Coupling Needle Point, 145 mm



03.010.170 Hammer Guide



03.019.017 Depth Gauge for Multiloc Humeral Nailing System



03.010.429 Direct Measuring Device for Locking Screws to 100 mm for IM Nails

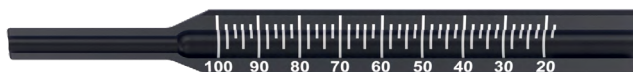

03.010.500 Silicone Handle with Quick Coupling



03.010.522 Spiral Combination Hammer, 500 Grams



03.037.008 8 mm, cannulated curved Awl



03.043.001 Universal Chuck

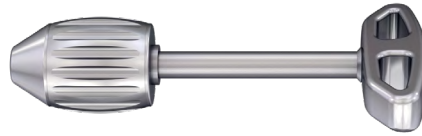

03.045.001 Screwdriver, XL25



03.045.002 Retention Pin for Screwdriver XL25



03.045.003 Screwdriver, short, XL25



03.045.004 Retention Pin for Screwdriver, short, XL25



03.045.018 Guide Wire with Drill Tip, Ø 3.2 mm, 400 mm



03.045.019 Protection Sleeve, Ø 11/8



03.045.020 Drill Sleeve, Ø 4.2 mm



03.045.022 Drill Bit, calibrated, Ø 4.2 mm, extra-long



03.045.035 Direct Measuring Device for Intramedullary Nails



03.045.036 Tube for Direct Measuring Device



03.037.031 Combination Wrench 11 mm / Blade / Screw



321.170 Pin Wrench Ø 4.5 mm, length 120 mm



Optional Instruments

03.010.093 Reaming Rod Push Rod with Ball Handle



03.010.495 IM Reduction Tool, curved, with Quick Coupling



03.010.496 T-Handle, cannulated, with Quick Coupling



03.045.005 Screwdriver XL25 Quick Coupling Hex 12 mm



03.045.006 Retention Pin for Screwdriver with Quick Coupling, Coupling Hex 12 mm, XL25



03.045.007 Screwdriver, short, XL25, Quick Coupling Hex 12 mm



03.045.008 Retention Pin for Screwdriver with Quick Coupling, Hex 12 mm, short, XL25



Optional Instruments

03.045.009 Sleeve for Screwdriver



03.045.010 Sleeve for Screwdriver, short



03.045.029 Reamer, Ø 5.5 mm



03.140.027 Large Cannulated Handle with Quick Coupling, 12 mm Hex



03.010.502 13.0 mm Protection Sleeve for RAFN Retrograde Femoral Nail



03.010.507 Multihole Wire Guide for Expert Retrograde Femoral Nail



MRI Information

MR SAFETY INFORMATION



Non-clinical testing has demonstrated the DePuy Synthes RFN-Advanced Retrograde Femoral Nailing System is MR Conditional. A patient with these devices can be safely scanned in an MR system meeting the following conditions:

- Static magnetic field of 1.5 T or 3.0 T transmit quadrature-driven coil only
- Maximum spatial field gradient of 2,000 gauss/cm (20 T/m) for 1.5 T or 3.0 T
- Maximum MR system reported, whole-body averaged specific absorption rate (SAR) of 2 W/kg (Normal Operating Mode)

Under the scan conditions defined above, the DePuy Synthes RFN-Advanced Retrograde Femoral Nailing System is expected to produce a maximum temperature rise of 5 °C in 1.5 T and 2 °C in 3.0 T for 15 minutes of continuous scanning. In non-clinical testing, the image artifact caused by the device extends approximately 141 mm from the DePuy Synthes RFN-Advanced System when imaged with a gradient echo pulse sequence and a 3.0 T MRI system.

▲ Precaution:

It is recommended that the device be kept as far away from the coil wall as possible.

Please also refer to the package insert(s) or other labeling associated with the devices identified in this surgical technique for additional information.

CAUTION: Federal Law restricts these devices to sale by or on the order of a physician.

Some devices listed in this surgical technique may not have been licensed in accordance with Canadian law and may not be for sale in Canada. Please contact your sales consultant for items approved for sale in Canada.

Not all products may currently be available in all markets.



Manufactured by:
Synthes USA, LLC
1101 Synthes Avenue
Monument
CO 80132

Synthes GmbH
Luzernstrasse 21
4528 Zuchwil
Switzerland

Synthes GmbH
Eimattstrasse 3
4436 Oberdorf
Switzerland

To order (USA): 800-523-0322 Tel: +41 61 965 61 11
To order (Canada): 844-243-4321 Fax: +41 61 965 66 00

Note: For recognized manufacturer, refer to the product label.

www.depuysynthes.com