

# Cannulated Screws

## 3.0/3.5/4.0/4.5/6.5/7.0/7.3

### Surgical Technique

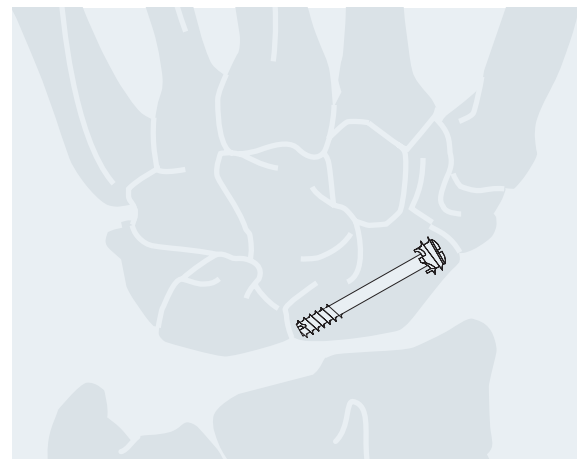
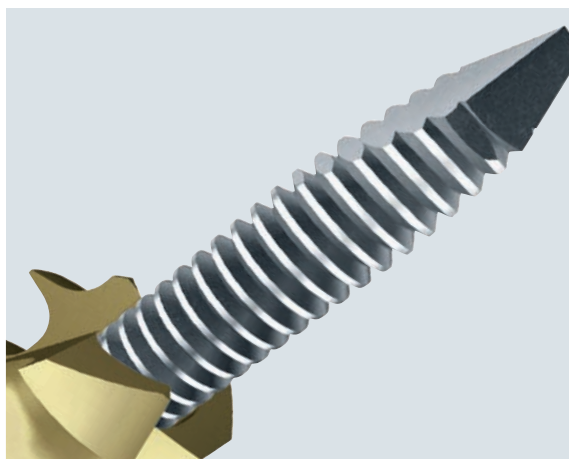
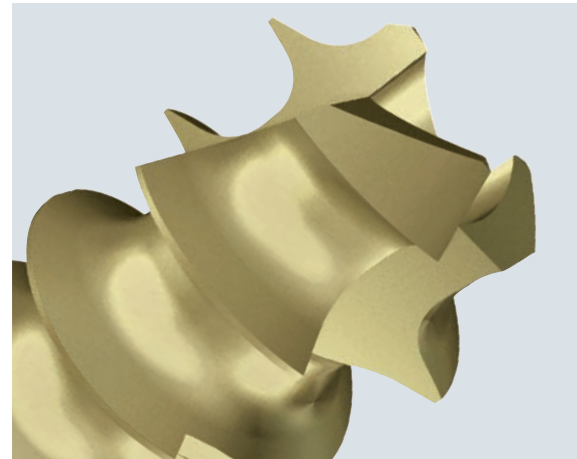
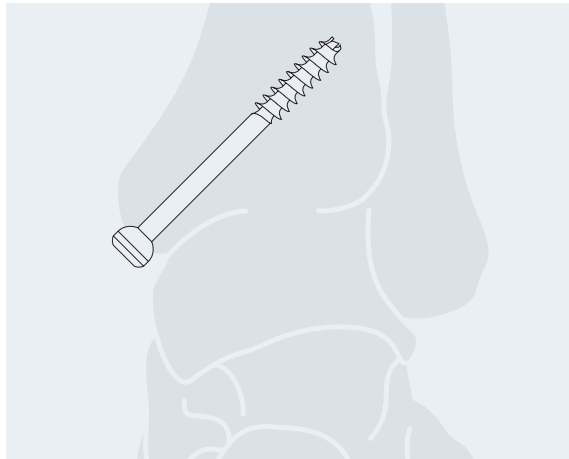
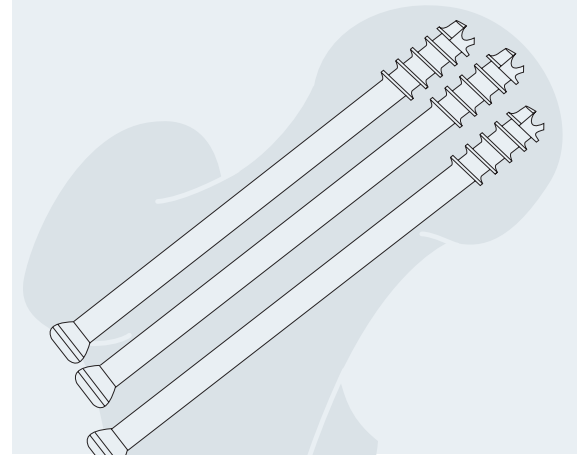
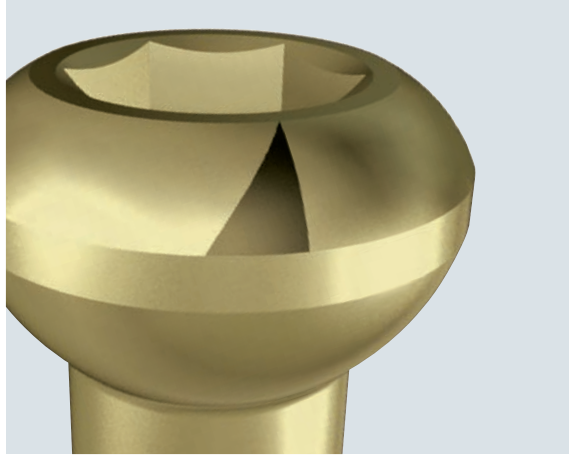

This publication is not intended for distribution in the USA.

Instruments and implants approved by the AO Foundation.



# Table of Contents

---

<b>Indications</b>	2
<b>Implants</b>	4
<b>Surgical technique</b>	
All cannulated screws (illustrated using the cannulated screw 4.5)	7
Cannulated screw 3.0 with support screw	13
Open insertion for cannulated screw 6.5/7.3	17
<b>Implant removal</b>	18
<b>Instrument cleaning</b>	19
<b>MRI Information</b>	20

---

 Image intensifier control

### **Warning**

This description alone does not provide sufficient background for direct use of DePuy Synthes products. Instruction by a surgeon experienced in handling these products is highly recommended.

### **Processing, Reprocessing, Care and Maintenance**

For general guidelines, function control and dismantling of multi-part instruments, as well as processing guidelines for implants, please contact your local sales representative or refer to:

<http://emea.depuyshnthes.com/hcp/reprocessing-care-maintenance>

For general information about reprocessing, care and maintenance of Synthes reusable devices, instrument trays and cases, as well as processing of Synthes non-sterile implants, please consult the Important Information leaflet (SE\_023827) or refer to:

<http://emea.depuyshnthes.com/hcp/reprocessing-care-maintenance>

# Indications

---

## CSS 3.0

Fixation of fractures of the forearm, hand and foot, e.g.:

- fractures and arthrodeses of the carpals and metacarpals
  - fractures of the distal radius and radial head
  - metatarsal fractures
- 

## CSS 3.5

Fixation of fractures with small fragments, e.g.:

- wrist fractures
  - metacarpal and metatarsal fractures and fixation in metacarpal and metatarsal osteotomies
  - tarsal fractures
  - transcondylar humeral fractures in children
- 

## CSS 4.0

Fixation of fractures with medium fragments, e.g.:

- tarsal and metatarsal fractures and fixation in metatarsal and phalangeal osteotomies
  - tarsometatarsal and metatarsophalangeal arthrodeses
  - ligament fixations
  - hallux valgus corrections
- 

## CSS 4.5

Fixation of fractures with medium fragments, e.g.:

- malleolar fractures
  - pilon tibial fractures
  - fractures of the calcaneus and talus
  - tibial plateau fractures
  - carpal and tarsal arthrodeses
- 

## CSS 6.5, 7.0 und 7.3

Fixation of fractures with large fragments, e.g.:

- femoral neck fractures
- intercondylar femoral fractures
- epiphyseolysis of the femoral head
- ankle arthrodeses
- iliosacral dislocations

## Warning:

These devices are not approved for screw attachment or fixation to the posterior elements (pedicles) of the cervical, thoracic or lumbar spine.

---

## Fields of application

### Adults

Use correspondingly smaller screws for children, adolescents and adults of small stature.

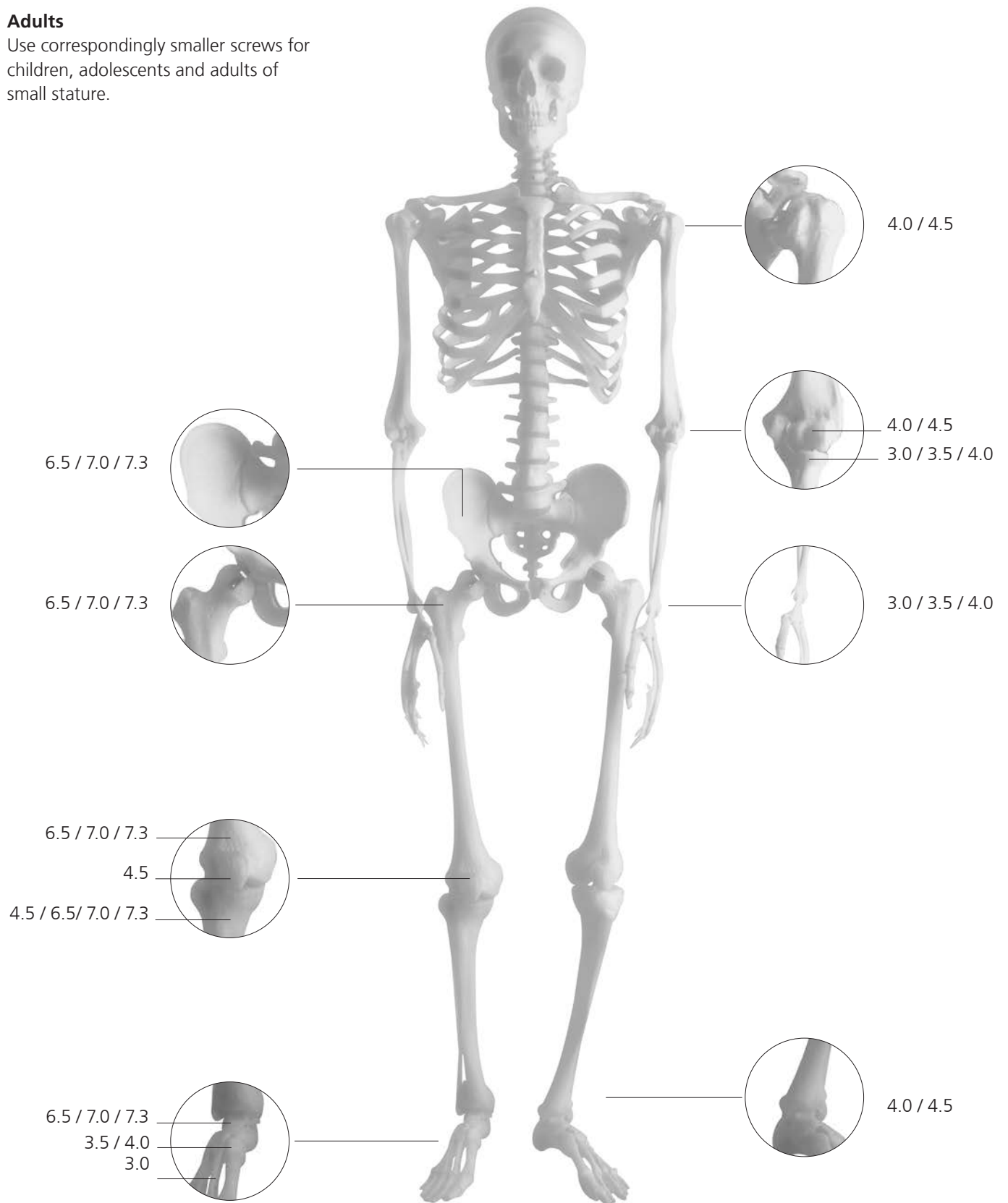

# Implants

## Cannulated Screws

Short thread



Long thread



Full thread



Cannulated Screws	Recess**	Art. no. short thread	long thread	full thread	External diameter	Shaft diameter	Length
3.0 self-drilling	4.0 mm cruciform	X02.608-650 * 1)	X02.714-749 *	-	3.0 mm	2.0 mm	8- 50 mm
3.5	2.5 mm Hex	X05.110-150, self-drilling 205.010-060, 205.028S, 205.030S, 205.034S, 205.038S	-	X05.310-350, self-drilling * 205.210-250	3.5 mm	2.4 mm	10- 50 mm
4.0 self-drilling	2.5 mm Hex	X07.610-672 214.420-472, 214.454S, 214.456S 2)	X07.716-772	-	4.0 mm	2.6 mm	10- 72 mm
4.5 self-drilling	3.5 mm Hex	X14.520-580	-	X14.720-777	4.5 mm	3.1 mm	20- 80 mm
6.5 self-drilling	4.0 mm Hex	X08.401-425	X08.431-452 3)	X08.460-482	6.5 mm	4.8 mm	20-150 mm
7.0	3.5 mm Hex	X08.151-171, self-drilling 208.030-130 4)	X08.174-191, self-drilling 209.045-130	X08.201-223, self-drilling 209.420-530	7.0 mm	4.5 mm	20-130 mm
7.3 self-drilling	4.0 mm Hex	X08.830-950	X09.845-950 5)	X09.620-730	7.3 mm	4.8 mm	20-150 mm

All cannulated screws have reverse-cutting flutes, allowing efficient removal of even firmly embedded screws.

- 1) Additionally available 402.614VS - 402.640VS, TAV, sterile
- 2) Additionally available 407.610VS - 407.650VS, TAV, sterile
- 3) Additionally available 408.230VS - 408.330VS, TAV, sterile
- 4) Additionally available 414.520VS - 414.572VS, TAV, sterile, self-drilling
- 5) Additionally available 408.830V - 4408.930V, TAV

For additional foot notes see next page.

### Additional lengths for 6.5 and 7.3 cannulated screws

Cannulated Screws	Recess**	Art. no. short thread	long thread	full thread	External diameter	Shaft diameter	Length
6.5 self-drilling	4.0 mm Hex	X08.426S – 428S	X08.453S – 455S	X08.483S – 487S	6.5 mm	4.8 mm	140–180 mm
7.3 self-drilling	4.0 mm Hex	208.955S – 980S	209.955S – 980S	209.735S – 780S	7.3 mm	4.8 mm	135–180 mm

**Note:** These additional lengths are available sterile only (the 7.3 cannulated screws are only available in stainless steel).

\*\* cruciform



X = 2: Stainless Steel  
X = 4: TAN/TAV

Hex



\* Available nonsterile or sterile-packed. Add "s" to catalogue number to order sterile product

**Guide wires**



Cannulated Screw	Guide Wire Art. no.	Diameter	Length	Tip
3.0	292.622 / 292.623	1.1 mm	150 mm	Threaded tip with / or triangular trocar
3.5	292.620	1.25 mm	150 mm	Threaded tip with rectangular trocar
4.0	292.620	1.25 mm	150 mm	Threaded tip with rectangular trocar
4.5	292.720	1.6 mm	150 mm	Threaded tip with rectangular trocar
7.0	292.650	2.0 mm	230 mm	Threaded tip with rectangular trocar
6.5/7.3	292.680	2.8 mm	300 mm	Threaded tip with triangular trocar
	292.810	2.8 mm	300 mm	Drill bit

**Washers**

All cannulated screws can be used with or without a washer (or support screw for the cannulated screw 3.0).



Cannulated Screw	Washer Art. no.	Outside diameter	Internal diameter
3.0	X19.972	6.5 mm	3.3 mm
3.5	X19.980	7.0 mm	3.6 mm
4.0	X19.980	7.0 mm	3.6 mm
4.5	X19.910	10.0 mm	4.6 mm
7.0	X19.990	13.0 mm	6.6 mm
6.5/7.3	X19.990	13.0 mm	6.6 mm

**Washer, spherical**

Prevents projection of the screw head, when the screw must be inserted at an acute angle.

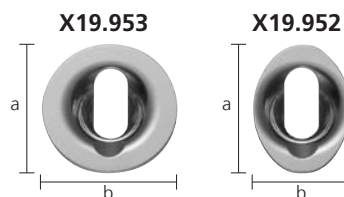

Cannulated Screw	Washer Art. no.	Height (a)	Width (b)	Depth
6.5/7.0/7.3	X19.952	22 mm	16 mm	6.1 mm
6.5/7.0/7.3	X19.953	22 mm	22 mm	6.1 mm

**Support Screw for Cannulated Screw 3.0**

Outside diameter 5.5 mm, core diameter 4.25 mm, length 3 mm, with cannulation and hexagonal socket 3.2 mm (219.890. 419.890)





# Surgical technique for all cannulated screws

The following surgical technique is explained using the example of a malleolar fracture.

## 1

### Reduce fracture and insert guide wire

After a stab incision, advance the drill sleeve or drill sleeve assembly through the soft tissues to the bone. Insert the guide wire through the drill sleeve to the desired depth and position.

 Remove the drill sleeve and check the position of the guide wire under the image intensifier.

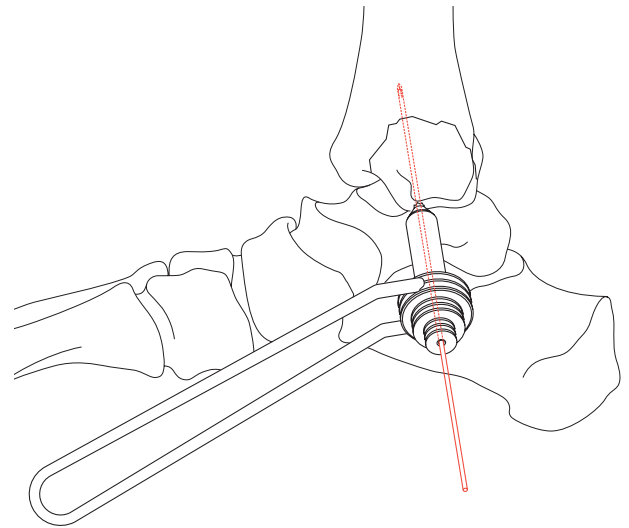

### Required instruments

Cannulated Screw	Guide Wire	Drill Sleeve
3.0	Ø 1.1 mm (292.622/292.623)	Double Drill Sleeve 2.0/1.1 (312.151)
3.5	Ø 1.25 mm (292.620)	Double Drill Sleeve 2.7/1.25 (312.350)
4.0	Ø 1.25 mm (292.620)	Double Drill Sleeve 2.7/1.25 (312.350)
4.5	Ø 1.6 mm (292.720)	Percutaneous Drill Sleeve Assembly: – Protection Sleeve 9.5/7.0 (312.770) – Drill Sleeve 7.0/3.2 (312.760) – Drill Sleeve 3.2/1.6 (312.750) – Trocar Ø 1.6 mm (312.740)
7.0	Ø 2.0 mm (292.650)	Percutaneous Drill Sleeve Assembly: – Protection Sleeve 11.0/8.0 (319.340) – Drill Sleeve 8.0/4.5 (319.330) – Drill Sleeve 4.5/2.0 (319.320) – Trocar Ø 2.0 mm (319.310)
6.5/7.3	Ø 2.8 mm (292.680, 292.810/ 900.726)	Drill Sleeve Assembly: – Protection Sleeve 12.0/8.5 (312.050) – Drill Sleeve 8.5/2.8 (312.080) – Trocar Ø 2.8 mm (312.020)

## 2

### Option: Insert guide wires in parallel (only for cannulated screws 4.5/6.5/7.0/7.3)

Slide the non-adjustable guide sleeve (1) of the parallel guide over the already inserted guide wire. Move the (adjustable) guide sleeve (2) to the desired position and tighten the nut. Insert the second guide wire.

Insert the desired number of parallel guide wires as described and remove the parallel guide.

**Note:** The placement of three guide wires is recommended to achieve adequate rotational stability.

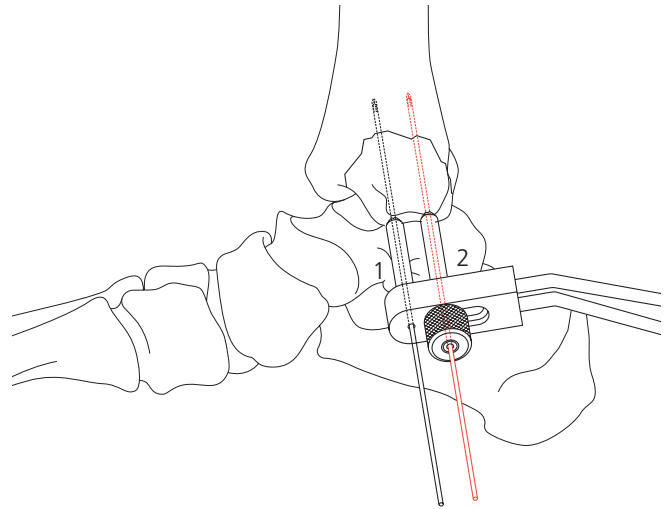

### Required instruments

Cannulated Screw	Parallel Guide for Guide Wires
4.5	adjustable (312.730)
7.0	<ul style="list-style-type: none"> <li>– non-adjustable (312.710)</li> <li>– for percutaneous insertion (319.300)</li> </ul>
7.3	<ul style="list-style-type: none"> <li>– adjustable (312.010)</li> <li>– for open insertion (312.070); see the section on "Open insertion for cannulated screw 7.3"</li> <li>– for percutaneous insertion (312.692)</li> </ul>

---

### 3

#### Drilling

For self-tapping screws (see page 4), the desired length must be predrilled with the cannulated drill bit. Predrilling the near cortex is also recommended for hard bones when using the self-drilling screws.

For the following screws, drilling and tapping is required:

205.010-060, 205.028S, 205.030S, 205.034S, 205.038S

205.210-250

208.030-130

209.045-130

209.420-530

#### Required instruments

Cannulated Screw	Drill Bit, cannulated
3.0	Ø 2.0 mm (310.221)
3.5	Ø 2.7 mm (310.670)
4.0	Ø 2.7 mm (310.670)
4.5	Ø 3.2 mm (310.650)
7.0	Ø 4.5 mm (315.690)
6.5/7.3	Ø 5.0 mm (310.630)

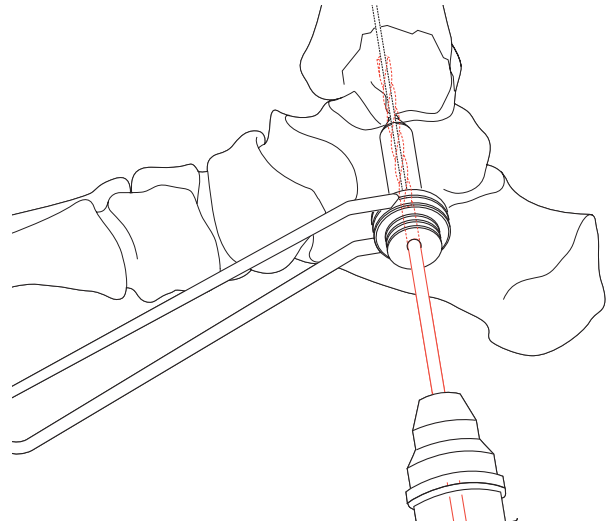

---

### 4

#### Tapping

Where necessary, tap the near cortex with the cannulated tap.

#### Required instruments

Cannulated Screw	Tap
3.5	311.390
7.0	311.690

## 5

### Option: Countersinking

Where the bone is surrounded by only a thin layer of soft tissue, the screw head may be countersunk using the cannulated countersink to prevent projection of the screw head. Countersinking also facilitates screw insertion.

**Note:** If the countersink fails to bite, the near cortex can be predrilled using the cannulated drill bit.

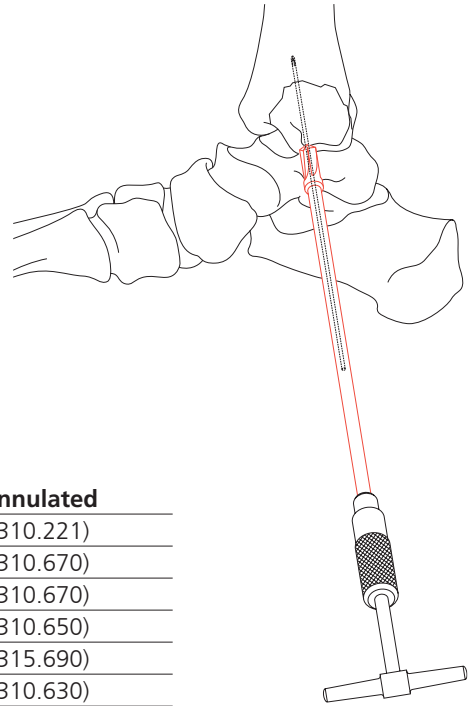

### Required instruments

Cannulated Screw	Countersink, cannulated	Drill Bit, cannulated
3.0	310.804	∅ 2.0 mm (310.221)
3.5	310.860	∅ 2.7 mm (310.670)
4.0	310.860	∅ 2.7 mm (310.670)
4.5	310.850	∅ 3.2 mm (310.650)
7.0	310.790	∅ 4.5 mm (315.690)
6.5/7.3	310.780	∅ 5.0 mm (310.630)

## 6

### Determine screw length

#### Cannulated screw 3.0/3.5/4.0

Advance the direct measuring device for cannulated screws down to the cortical bone. Read off the appropriate screw length directly on the scale.

#### Cannulated screw 4.5/6.5/7.0/7.3

Insert the protection sleeve and slide the direct measuring device over the guide wire. Read off the appropriate screw length directly on the scale.

**Note:** Only use the guide wire in its original length to ensure correct measurement.

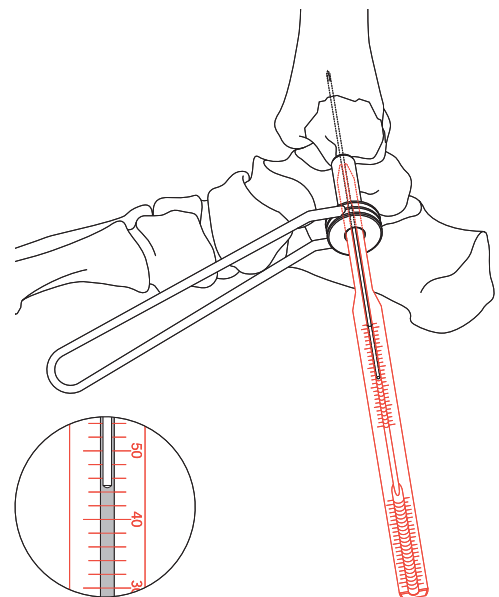

### Required instruments

Cannulated Screw	Direct Measuring Device	Protection Sleeve
3.0	319.702	–
3.5	319.150	–
4.0	319.150	–
4.5	319.170	312.770
7.0	319.210	319.340
6.5/7.3	319.700	312.050

## 7

### Insert screw

Insert the appropriate cannulated screw using the cannulated screwdriver and the holding sleeve.

### Cannulated screw 4.5/6.5/7.0/7.3

Insert the appropriate cannulated screw through the protection sleeve using the hexagonal cannulated screwdriver. Next, remove the protection sleeve.



Remove and dispose of the guide wire. Check the final position of the screw under the image intensifier.

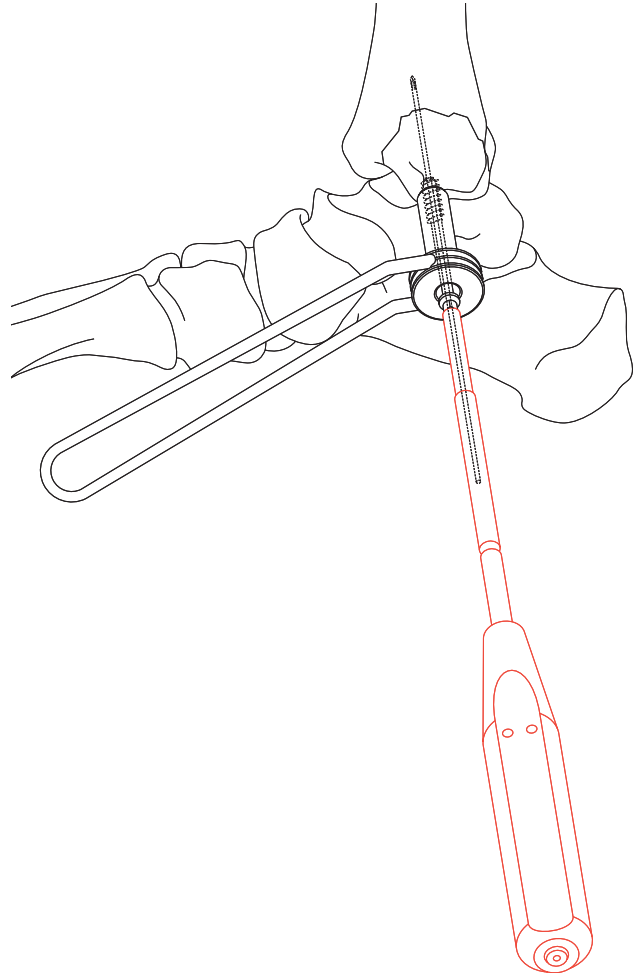

### Required instruments

Cannulated Screw	Screwdriver, cannulated	Washer	Holding Sleeve	Protection Sleeve
3.0	Cruciform screwdriver (314.463)	X19.972	313.969	–
3.5	Hexagonal screwdriver (314.290)	X19.980	314.080 or 314.060	–
4.0	Hexagonal screwdriver (314.290)	X19.980	314.080 or 314.060	–
4.5	Hexagonal screwdriver (314.200)	X19.910	–	∅ 9.5/7.0 mm (312.770)
7.0	Hexagonal screwdriver (314.190)	X19.990	–	∅ 11.5/7.0 mm (319.340)
6.5/7.3	Hexagonal screwdriver (314.050)	X19.990	–	∅ 12.5/7.0 mm (312.050)

X = 2: Stainless Steel

X = 4: TAN

---

**Procedure for osteoporotic bones:**

In osteoporotic bone, the screw head can be prevented from sinking into the bone by using a washer (or spherical washer). Avoid tightening the screw tightly, because otherwise the thread may strip and the screw's grip in the bone could be compromised.

**Note:** The spherical washer prevents projection of the screw head, when the screw must be inserted at an acute angle (e.g., in ankle arthrodesis). The screw (6.5/7.0/7.3) can be inserted at an angle of 0–70°.

It is recommended that the Ø 13.0 mm Drill Bit (351.270) and the Ø 17.0/15.0 mm Protection Sleeve (357.530) be used as the double drill sleeve for the spherical washer.

**Additional instruments required for use of the spherical washer**

<b>Cannulated Screw</b>	<b>Drill Bit, cannulated</b>	<b>Washer</b>	<b>Protection Sleeve</b>
7.0	Ø 13.0 mm (351.270)	X19.952 or X19.953	Ø 17.0/15.0 mm (357.530)
6.5/7.3	Ø 13.0 mm (351.270)	X19.980 or X19.953	

X = 2: Stainless Steel  
X = 4: TAN

# Surgical technique for cannulated screw 3.0 with support screw

## Application methods

- Intra-articular  
With countersunk support screw
- Extra-articular  
With cannulated screw technique
- Extra-articular in cases of poor bone quality  
With washer

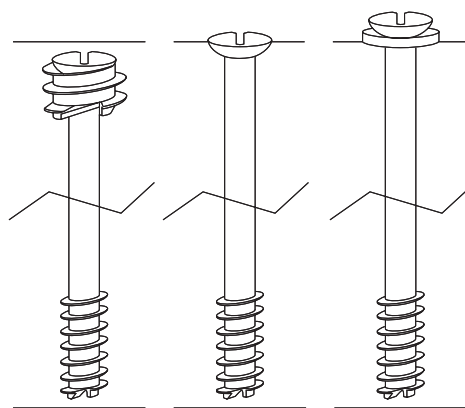

## Functional characteristics

The support screw is anchored in cancellous bone by its thread. It supports the countersunk head of the cannulated screw in cancellous bone.

Reduction and compression of the fracture is achieved by inserting the cannulated screw.

Precise compression adjustment.

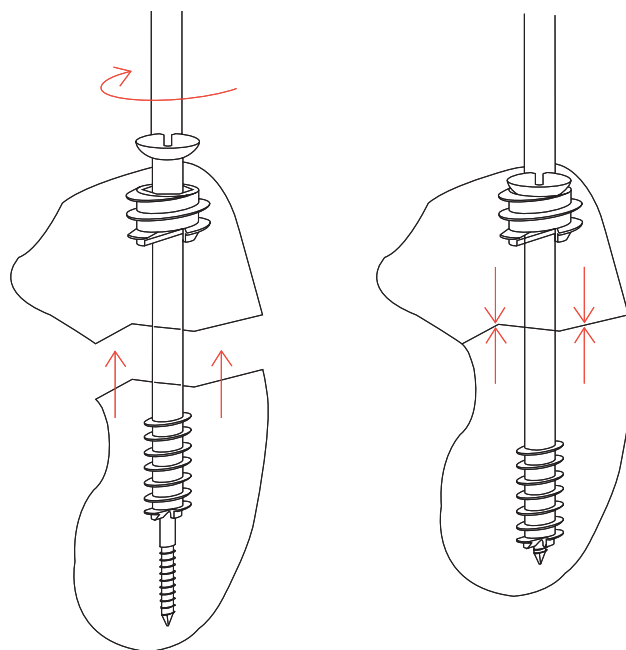

The following surgical technique uses a scaphoid bone fracture as an example. The use of a support screw is generally recommended for scaphoid bone fractures, with the exception of small proximal pole fractures. With the use of a support screw, the screw head can be countersunk, thus reducing the risk of postoperative articular restrictions in the range of motion.

## 1

### Reduce fracture and insert guide wire

After the incision, temporarily reduce dislocated fragments with a Kirschner wire. Insert the Guide Wire Ø 1.1 mm with Threaded Tip (292.622) through the drill sleeve 1.1 of the Double Drill Sleeve 2.0/1.1 (312.151) and advance it into the bone from distal/lateral to proximal/medial until the threaded tip is anchored in the far cortex.

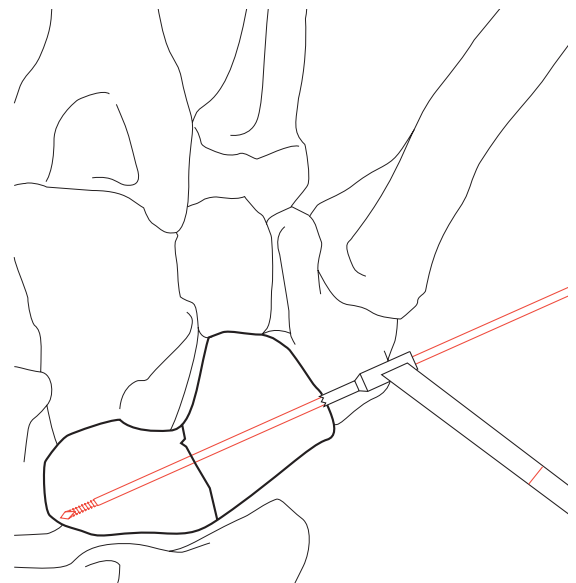
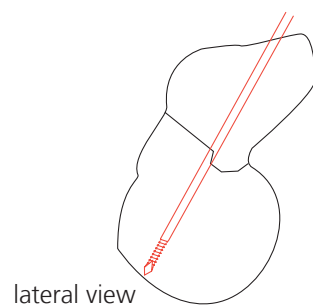

## 2

### Option: Predrilling

Predrilling can be advantageous in dense bone as it reduces torque during screw insertion. Slide the Double Drill Sleeve 2.0/1.1 (312.151) with the Cannulated Drill Bit Ø 2.0 mm (310.221) over the guide wire and drill through the near cortex. Slowly and carefully, while running the drill forward, withdraw the drill bit to ensure the guide wire stays in place.

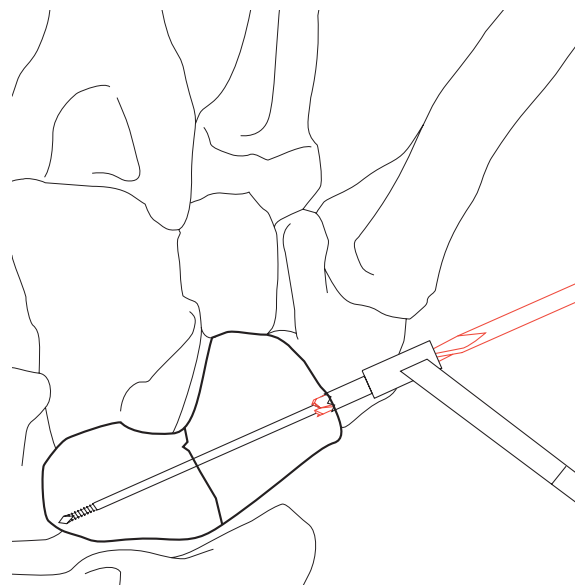



---

### 3

#### Ream the seat of the support screw

Slide the Double Drill Sleeve 5.5/4.3 (312.153) with the Cannulated Countersink (310.804) over the guide wire and ream to a depth of 5 mm. The reaming depth is indicated on the scale of the countersink.

The use of a drill is recommended, as reaming will be more precise than if performed manually.

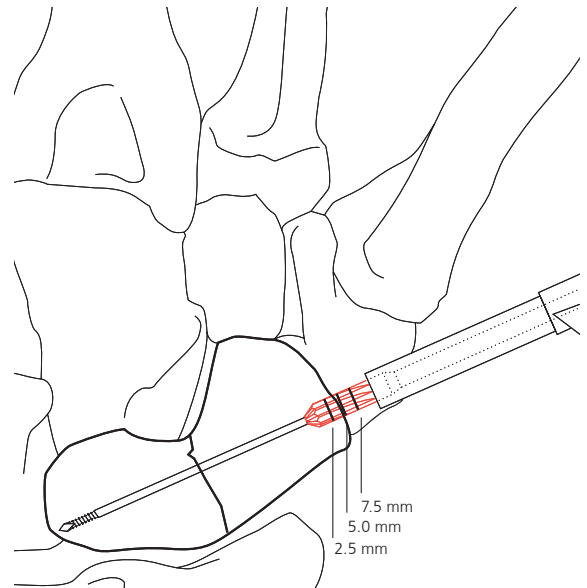

---

### 4

#### Insert the support screw

Insert the support screw 3 to 4 mm under the bone surface using the cannulated hexagonal screwdriver (Cannulated Hexagonal Screwdriver Shaft 314.464 and Handle 311.430). Thus, the head of the cannulated screw, buttressed by the support screw, will be fully countersunk.

**Note:** Make sure the shortest distance between the support screw and the bone surface is approximately 3 mm.

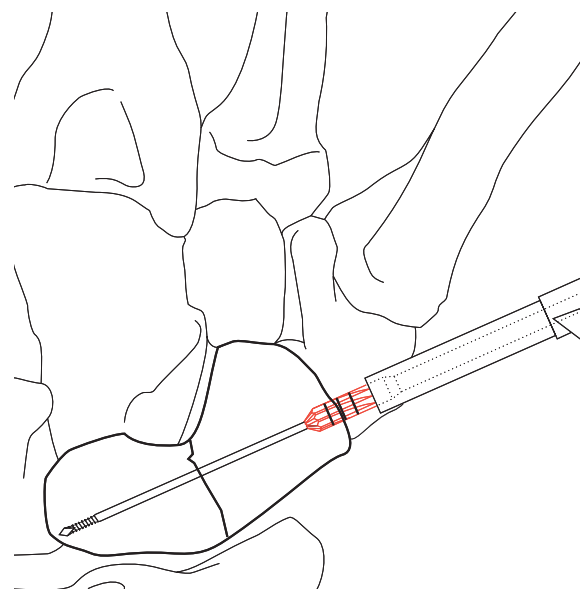

## 5

### Determine screw length

Slide the Direct Measuring Device for Cannulated Screws  $\varnothing$  3.0 mm (319.702) onto the guide wire and position it on the support screw. The required screw length is indicated directly on the measuring device.

**Note:** Do not introduce the measuring device into the support screw. The length has to be measured at the surface of the screw head, or else the screw will be 3–5 mm shorter than the guide wire.

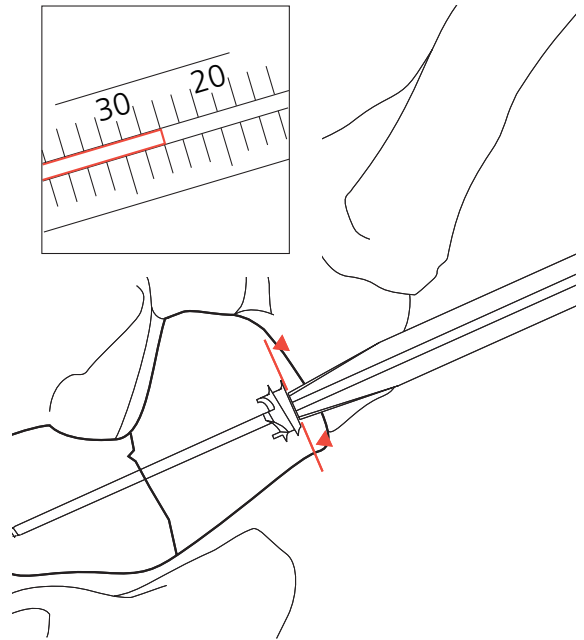

## 6

### Insert the cannulated screw

Insert the selected cannulated screw using the Cruciform Cannulated Screwdriver (314.463) with Holding Sleeve (313.969). When tightening the screw, the fracture can be reduced precisely and compression can be performed in a controlled way.

 Remove and dispose of the guide wire. Check the final position of the screw under the image intensifier.

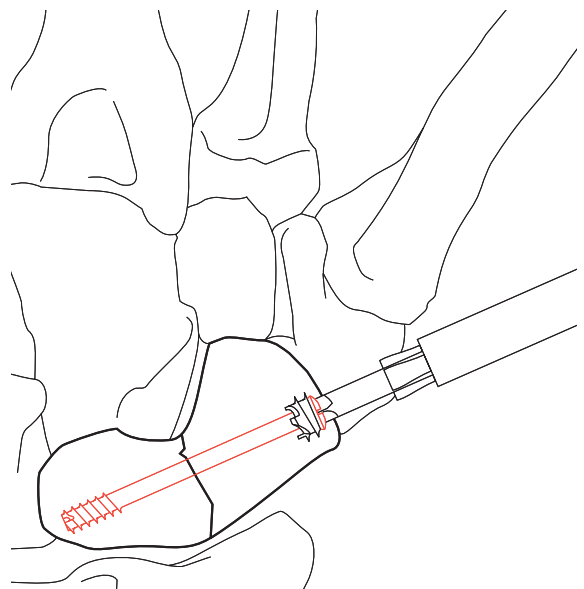

# Open insertion for cannulated screw 6.5/7.3

## 1

### Reduce fracture and make incision

Reduce the fracture and make an incision of approx. 5 cm.

## 2

### Set angle of the wire guide

Use the Parallel Guide for Guide Wires with Adjustable Angles (312.070) to insert several parallel guide wires at a selected angle to the bone.

Set the desired angle (markings of 125°, 130°, 135° and 140°) on the wire guide and position the wire guide on the bone.

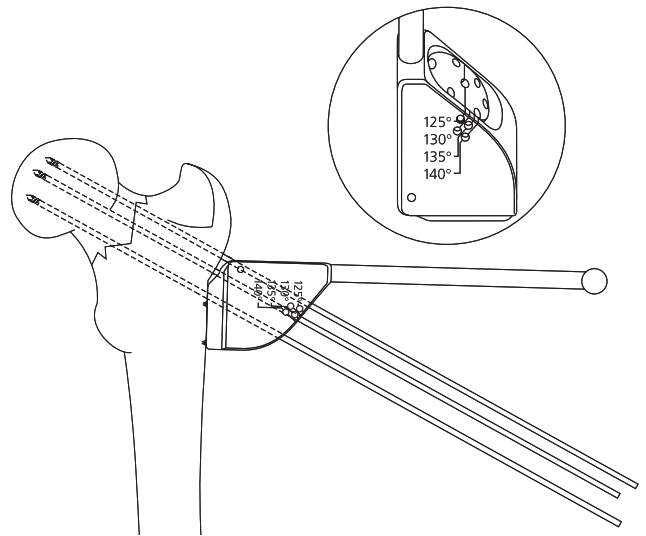

## 3

### Select position of the parallel guide wires

- Pattern of holes on the parallel wire guide.
- Washers may be used with the screws if guide wires are inserted in non-adjacent holes of the wire guide.
- Placing the guide wires through adjacent holes will allow clearance for screws but not for washers.

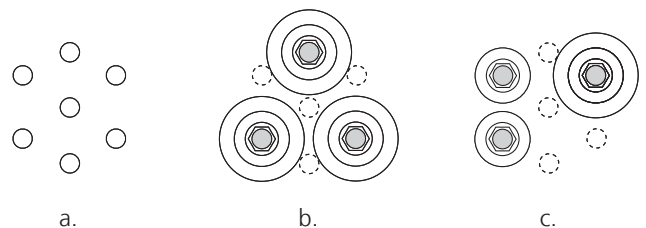

## 4

### Insert guide wires and screws

Insert the desired number of guide wires 5–10 mm below articular cartilage and remove the wire guide. Determine the screw lengths and insert screws.

See steps 1–6, pages 6–11, for a precise description.

# Implant removal

---

Expose the screw head and remove the screws using the special screwdriver for the removal of cannulated screws.

## Precaution

Do not use the cannulated screwdriver for implant removal.

## Required instruments

Cannulated Screw	Screwdriver	Screwdriver Shaft and Handle
3.0	–	Cruciform Screwdriver Shaft (314.465) and Handle with Quick Coupling (311.430)
3.5	–	Hexagonal Screwdriver Shaft (314.030) and Handle with Quick Coupling (311.430)
4.0	–	Hexagonal Screwdriver Shaft (314.030) and Handle with Quick Coupling (311.430)
4.5	–	Hexagonal Screwdriver Shaft (314.150) and T-Handle with Quick Coupling (311.440)
7.0	Hexagonal Screwdriver (314.270)	–
6.5/7.3	Hexagonal Screwdriver (313.930)	Hexagonal Screwdriver Shaft (314.040) and Quick Coupling (338.490) or Universal Chuck with T-Handle (393.100)

# Instrument cleaning

---

Clean the cannulated instruments thoroughly after each use. This helps maintain the correct operation of the instruments.

The instrument cannulations can be cleaned during operations using the cleaning stylet.

The instrument cannulations can be cleaned postoperatively using the cleaning stylet and cleaning brush.

## Required instruments

<b>Cannulated Screw</b>	<b>Cleaning Stylet</b>	<b>Cleaning Brush</b>
3.0	Ø 1.1 mm (319.292)	Ø 1.25 mm (319.291)
3.5	Ø 1.25 mm (319.380)	Ø 1.35 mm (319.250)
4.0	Ø 1.25 mm (319.380)	Ø 1.35 mm (319.250)
4.5	Ø 1.6 mm (319.350)	Ø 1.75 mm (319.260)
7.0	Ø 2.0 mm (319.360)	Ø 2.1 mm (319.270)
6.5/7.3	Ø 2.8 mm (319.460)	Ø 2.9 mm (319.240)

## MRI Information

---

### **Torque, Displacement and Image Artifacts according to ASTM F 2213-06, ASTM F 2052-06e1 and ASTM F2119-07**

Non-clinical testing of worst case scenario in a 3 T MRI system did not reveal any relevant torque or displacement of the construct for an experimentally measured local spatial gradient of the magnetic field of 3.69 T/m. The largest image artifact extended approximately 169 mm from the construct when scanned using the Gradient Echo (GE). Testing was conducted on a 3 T MRI system.

### **Radio-Frequency-(RF-)induced heating according to ASTM F2182-11a**

Non-clinical electromagnetic and thermal testing of worst case scenario lead to peak temperature rise of 9.5 °C with an average temperature rise of 6.6 °C (1.5 T) and a peak temperature rise of 5.9 °C (3 T) under MRI Conditions using RF Coils [whole body averaged specific absorption rate (SAR) of 2 W/kg for 6 minutes (1.5 T) and for 15 minutes (3 T)].

---

**Precautions:** The above mentioned test relies on non-clinical testing. The actual temperature rise in the patient will depend on a variety of factors beyond the SAR and time of RF application. Thus, it is recommended to pay particular attention to the following points:

- It is recommended to thoroughly monitor patients undergoing MR scanning for perceived temperature and/or pain sensations.
  - Patients with impaired thermo regulation or temperature sensation should be excluded from MR scanning procedures.
  - Generally it is recommended to use a MR system with low field strength in the presence of conductive implants. The employed specific absorption rate (SAR) should be reduced as far as possible.
  - Using the ventilation system may further contribute to reduce temperature increase in the body.
-



